



Quality Engineered Plumbing Drainage Products

## 2019 LIST PRICE GUIDE



# Josam Company also offers Push-Fit Stainless Steel Drainage Systems, a complete line of Stainless Steel Drains, and the Pro-Plus Trench Drain System.

## Push-Fit Stainless Steel Drainage System



- Made of austenitic grade 316L Stainless Steel
- Gasketed "Push-Fit" design for cost effective installations
- 1 ½" through 8" pipe size
- Specific gasket materials for different product applications
- Pressure ratings at least four times higher than previous generation systems
- Capable of being used in vacuum systems
- Corrosion, Fire, Heat, Impact, & Thermal Stress Resistance
- Strong and Lightweight

## Complete Line of Stainless Steel Drains



- 8", 10", and 12" adjustable and non-adjustable round top floor drains
- 6", 8", 10", 12", and 16" adjustable and non-adjustable square top floor drains
- 2" through 8" no-hub outlets for easy connection to existing piping
- 6", 8", 12", and 16" wide trench drains
- Grates for the lightest to heaviest of loads
- 5/16", 3/4", and 3" slot and mini channels
- Ability to customize products to suit individual installation requirements

## Pro-Plus Trench Drain System

- SMC/GRP Construction
- 1.5 times Stronger than polymer concrete
- 70% Lighter than polymer concrete
- Shatterproof
- Available with and without slope
- 4", 8", and 12" nominal interior widths
- Load Class A-F

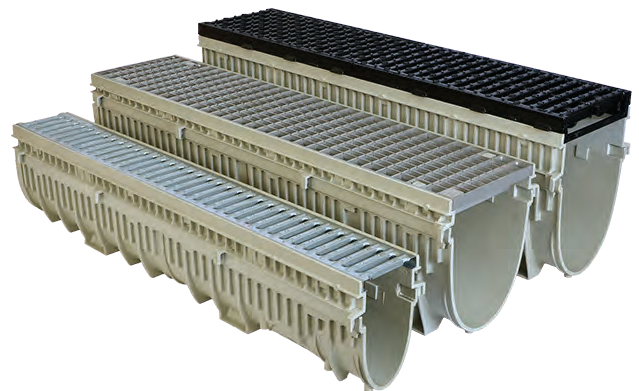

 **WARNING:** Cancer and Reproductive Harm - [www.p65warnings.ca.gov](http://www.p65warnings.ca.gov)

For more information on these quality engineered drainage products, please visit [www.josam.com](http://www.josam.com) or contact your local Josam representative.

## TABLE OF CONTENTS

### Specification Products

Closet Carriers.....	3-4
Fixture Carriers.....	5-6
Roof Drains .....	6-10
Floor Drains.....	11-19
Sanitary Floor Sinks.....	19-21
Cleanouts.....	22-24
Interceptors.....	25-29
Backwater Valves .....	30
Hydrants .....	31
Shock Absorbers.....	32
Trench Drains .....	32-33
Miscellaneous Products .....	33
Traps & Accessories.....	34-35

### Lite Line Products

Floor Drains.....	36-38
Roof Drains .....	38
Floor Sinks .....	39
Cleanouts.....	39
Interceptors.....	40
Shock Absorbers.....	40

### HOW TO USE THIS PRICE GUIDE

Every product in this guide is provided with list prices for the product and its options in a concise table. The description of each option is shown in the lower right corner of each page spread. A thumbnail photo is included for quick identification. All drawings and dimensions are available at [www.Josam.com](http://www.Josam.com).

All prices are list prices. Please consult your local Josam representative for your current multiplier.



*Partial or Full Domestic Content  
on Specification Product Line  
available upon request.*

Effective January 1, 2019

## List Price Guide – 2019 (LPG-2019)

Supersedes all previously published terms and conditions. Subject to change without notice.

Applicable to all sales of, and contracts to sell products of Josam Company

**CONTACT YOUR JOSAM REPRESENTATIVE FOR DETAILS ON DISCOUNT**

### **PAYMENT TERMS:**

For accounts with established credit, payment terms are 2% cash discount, payable 30 days from date of invoice, net 31 days. Invoices still unpaid after 31 days from date of invoice will be subject to interest charges of 1-1/2% per month. Minimum invoice: \$25.00 net. Confirmed irrevocable letter of credit or cash in advance of shipment is required for accounts without an established line of credit. Any terms and conditions appearing on your orders which are inconsistent with the terms of our quotation and conditions of sale shall be of no effect.

### **FREIGHT ALLOWANCE:**

#### **Specification Products (Pages 3-35)**

All shipments will be F.O.B. Michigan City, Indiana or Service Center. A freight allowance will be made on all shipments of \$5,000.00 net amount or more within the continental USA except for Alaska, Hawaii and Puerto Rico.

#### **Lite Line Products (Pages 36-40)**

All shipments will be F.O.B. Michigan City, Indiana or Service Center. A freight allowance will be made on all shipments of \$1,000.00 net amount or more within the continental USA except for Alaska, Hawaii and Puerto Rico.

**Specification Product Line products and Lite Line products may not be combined to obtain minimum freight requirements for full freight allowance.**

Full freight allowance is limited to normal ground services and does not include charges for specially expedited or guaranteed deliveries requiring air shipment or guaranteed motor freight contracts.

### **RETURN POLICY:**

Standard catalog material may be returned only upon written authorization of Seller. Requests to return material must be received by Josam Company within 60 days of date of original shipment made by Josam Company. Buyer must return material within 30 days from the date of Seller's written authorization. Credit will be issued to the Buyer's account toward purchase of additional material only. Obsolete, discontinued or specially produced items will not be accepted for return and credit.

Where return results from causes involving Buyer's responsibility, credit for saleable goods returned will be issued at invoice price less a 25% restocking charge for handling and inspection. Return of less than \$100.00 net price will not be allowed. For other than saleable goods returned, any necessary charges to render the returned material saleable will be added. Galvanized material will be credited at the same value as painted cast iron. Chrome plated material will be credited at the value of satin finish bronze. We will issue credit for returned parts only originally ordered as a part. On all returns, incoming and outgoing freight charges to and from Michigan City, Indiana, will be deducted from any credit allowed.

### **WARRANTY:**

Our products are warranted to be free of defects in material and workmanship for a period of one year from date of shipment, but our liability shall be limited solely to those defects, which our inspection finds to be due to our fault. Notification of a claim for defective material or workmanship must be given in writing to Josam Company. **WE SHALL NOT BE RESPONSIBLE FOR ANY LABOR CHARGES OR ANY LOSS, INJURY OR DAMAGES WHATSOEVER, INCLUDING INCIDENTAL OR CONSEQUENTIAL DAMAGES.** The sole and exclusive remedy shall be limited to the replacement or repair of the defective goods at the Seller's discretion. Before installation and use, Buyer shall determine the suitability of the product for his intended use and the Buyer assumes all risk and liability whatever in connection therewith.

Notification of a claim for material shortage or incorrect material must be given in writing to Josam Company within 15 days of shipment.

### **QUOTATIONS:**

Quotations are based on discount in effect at the time of quotation and will be protected on this basis for a period of 30 days from job bid due date.

### **EXPORT ORDERS:**

Factors which govern export orders differ from domestic orders. Please contact Josam International.

### **ACCEPTANCE OF ORDERS:**

All catalogs, price lists or other literature describing our products are not to be construed as offers to sell same. All orders are subject to acceptance by the general office of Seller in Michigan City, Indiana, either by shipment or by written acceptance. Your order, when shipped or accepted by us, shall constitute the complete contract between us, subject to and incorporating therein the terms and conditions herein contained, and any inconsistent provisions contained in your order shall not apply. Prices, discounts and special programs contained in any of our catalogs, price lists or other literature are subject to change without notice.

### **CANCELLATION:**

Orders are not subject to cancellation without our written consent. If an order is cancelled, the Buyer shall pay all costs incurred in connection with filling the order. Any items not cataloged or items not normally stocked by us and made or purchased to fill the order become the Buyer's property and must be paid for by the Buyer.

### **ILLUSTRATIONS, DESCRIPTIONS AND DIMENSIONS:**

All illustrations, descriptions, and detailed dimensions represent standard features and do not necessarily indicate all variations available. All weights stated in our catalogs, literature and drawings are approximate and are not guaranteed.

All designs, descriptions and dimensions are subject to change without notice, and unless Buyer specifically states otherwise on order, standard products in effect at time order is shipped will be supplied.

### **RISKS:**

Our responsibility ceases after the product has been delivered to the carrier in good order. It is the responsibility of the consignee to inspect each shipment carefully and file a claim with the carrier for any damage or shortage. Content shortages must be reported within 15 days after receipt of material.

### **DELIVERY:**

Shipping dates are estimates and time of delivery is not the essence of this sale or the contract therefor. We will ship as near schedule as possible. Under no circumstances will the Seller have any responsibility on account of any delays in manufacture, transportation, or otherwise. Material is subject to shipment in whole or in part, at our option, and each shipment is subject to immediate invoicing.

### **TAXES:**

Any sales, or manufacturers' tax imposed under existing or future statutes shall be added to the price herewith effective and shall be paid by the Buyer unless proper exemption certificates are filed with Josam Company.

**JOSAM COMPANY • MICHIGAN CITY, INDIANA 46360 • PHONE: (800) 365-6726 • FAX: (800) 627-0008**

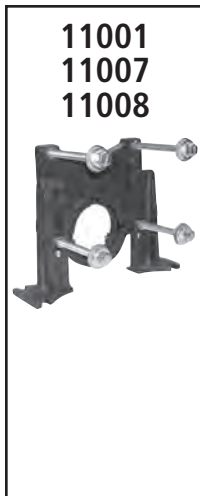

**11001  
11007  
11008**

CLOSET CARRIERS	
LIST PRICE	
SERIES NO	
11001 w/ 4" Pipe Grip Adapter	\$748.00
11007 w/ 3" Copper Ftg. Adapter	793.00
11008 w/ 4" Copper Ftg. Adapter	793.00
<b>ADD FOR OPTIONS:</b>	
-35* .....	\$548.00
*Not Available on 11007/11008	

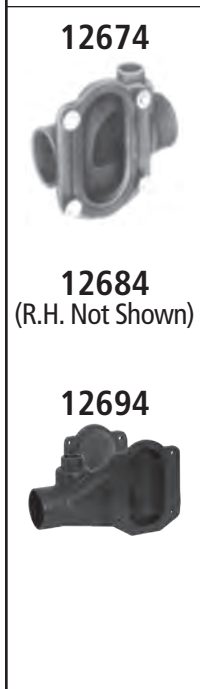

**12674**

**12684**  
(R.H. Not Shown)

**12694**

HORIZONTAL NO-HUB ADJUSTABLE				
LIST PRICE				
SERIES NO.	12674 Single L.H.	12684 Single R.H.	12694 Back-to-Back	
No-Hub	\$1,572.00	\$1,572.00	\$2,936.00	
-HS	1,572.00	1,572.00	2,936.00	
-58	2,122.00	2,122.00	3,691.00	
-HS-58	2,122.00	2,122.00	3,691.00	
<b>ADD FOR OPTIONS:</b>				
-1*	\$80.00	-HS	\$0.00	
-6*	85.00	-OR	0.00	
-6CU*	85.00	-PAC	0.00	
-10	0.00	-PAF	0.00	
-24*	Deduct 153.00	-PF	0.00	
-30	0.00	-PFG	0.00	
-30-2	0.00	-PS	0.00	
-32*	476.00	-SD (500 LB.)**	0.00	
-35	0.00	-SDH (750 LB.)	528.00	
-58	550.00	-TB*	191.00	
-AUX**	361.00	-VP	130.00	
-CR	00.00	-XSD (1000 LB.)*	721.00	
* Pricing for options is per fixture. Add or subtract twice for Back-to-Back Carriers				
** Not Available on 12694.				



**12724**

VERTICAL ADJUSTABLE BACK-TO-BACK, NO-HUB, ON STACK			
LIST PRICE			
SERIES NO	No-Hub	-HS	
12724 Back-to-Back 2" Vent	\$3,148.00	\$3,225.00	
<b>ADD FOR OPTIONS:</b>			
-1 .....	\$158.00	-HS .....	\$77.00
-6 .....	169.00	-HD4 .....	608.00
-6CU .....	169.00	-HVS4 .....	304.00
-10 .....	0.00	-OR .....	0.00
-24 .....	Deduct 310.00	-OS4 .....	304.00
-30 .....	0.00	-PAC .....	0.00
-30-2 .....	0.00	-PAF .....	0.00
-32 .....	953.00	-PF .....	0.00
-35 .....	0.00	-PFG .....	0.00
-49 .....	361.00	-PS .....	0.00
-50 .....	361.00	-SDH (750 LB.)	1,056.00
-53 .....	361.00	-TB .....	383.00
-54 .....	361.00	-VP .....	260.00
-58 .....	550.00	-VS4 .....	304.00
-CR .....	0.00	-XSD (1000 lb.)	1,441.00
-D4 .....	608.00		



**14004**

**14024**  
(R.H. Not Shown)

**14044**

VERTICAL CLOSE HUB & SPIGOT, OFFSET			
LIST PRICE			
SERIES NO			
14004 Sgl. L.H., L.H. 2" Vent		\$1,412.00	
14024 Sgl. R.H., R.H. 2" Vent		1,412.00	
14044 Back-to-Back, 2" Vent		2,417.00	
<b>ADD FOR OPTIONS:</b>			
-1*	\$80.00	-54 .....	\$361.00
-6*	85.00	-SD (500 lb.)**	0.00
-6CU*	85.00	-VP*	130.00
-21*	325.00	-XSD (1000 lb.)*	721.00
* Pricing for options is per fixture. Add or subtract twice for Back-to-Back Carriers			
** Not Available on 14044.			



**12704**

**12714**

VERTICAL ADJUSTABLE SINGLE, NO-HUB, ON STACK			
LIST PRICE			
SERIES NO	No-Hub	-HS	
12704 L.Hand 2" Vent	\$1,781.00	\$1,858.00	
12714 R.Hand 2" Vent	1,781.00	1,858.00	
<b>ADD FOR OPTIONS:</b>			
-1 .....	\$80.00	-HD4 .....	\$608.00
-6 .....	85.00	-HLH4 .....	304.00
-6CU .....	85.00	-HRH4 .....	304.00
-10 .....	0.00	-HS .....	77.00
-24 .....	Deduct 155.00	-LH4 .....	304.00
-30 .....	0.00	-OR .....	0.00
-30-2 .....	0.00	-PAC .....	0.00
-32 .....	476.00	-PAF .....	0.00
-35 .....	0.00	-PF .....	0.00
-49 .....	361.00	-PFG .....	0.00
-50 .....	361.00	-PS .....	0.00
-53 .....	361.00	-RH4 .....	304.00
-54 .....	361.00	-SD (500 lb.)	0.00
-58 .....	550.00	-SDH (750 lb.)	528.00
-CR .....	0.00	-TB .....	191.00
-D4 .....	608.00	-VP .....	130.00
		-XSD (1000 lb.)	721.00

### OPTION DESCRIPTIONS

-AUX	Auxiliary Inlet, 2"	-XSD	Extra Special-Duty 1,000 lb. Carrier
-CR	Compression Ring Carrier	-1	Positioning Frame
-D4	Double 4" No-Hub Branches	-6	Supply Pipe Support - Galvanized Pipe
-HD4	Double 4" Hub Branches	-6CU	Supply Pipe Support - Copper Pipe
-HLH4	Left-Hand 4" Hub Branch	-10	ABS Extension through 10-1/2" Wall
-HRH4	Right-Hand 4" Hub Branch	-21	Hanger Type Closet Adapter
-HS	Hub & Spigot	-24	Carrier for Floor-Mounted, Back-Outlet China Bowls
-HVS4	Vent Side 4" Hub Branch	-30	Cast Iron Adjustable Extension with Connector
-6CU	Supply Pipe Support - Copper	-30-2	Cast Iron Adjustable Extension with Connector and Test Cap
-LH4	Left-Hand 4" No-Hub Branch	-32	Carrier for Wide Chase Installations
-OR	O-Ring Carrier	-35	Closet Carrier for Wheelchair High Rough
-OS4	Opposite Vent 4" No-Hub Branch	-49	No-Hub High Auxiliary Inlet, Under Vent
-PAC	Pre-Assembled Carrier	-50	No-Hub High Auxiliary Inlet, Opposite Vent
-PAF	Prefab Adjustable Foot	-53	Threaded High Auxiliary Inlet, Under Vent
-PF	Pylon Foot, Standard	-54	Threaded High Auxiliary Inlet, Opposite Vent
-PFG	Alternate Prefab Faceplate Gasket (Standard with PAF)	-58	Horizontal No-Hub Cast Long Barrel
-PS	Foam Sleeve for Extension		
-RH4	Right-Hand 4" No-Hub Branch		
-SD	Special-Duty 500 lb. Carrier		
-SDH	Special-Duty 750 lb. Carrier		
-TB	Test Bracket		
-VP	Vandal-Proof Trim		
-VS4	Vent Side 4" No-Hub Branch		

	<b>VERTICAL CLOSE HUB &amp; SPIGOT, ON STACK</b>	
	<b>LIST PRICE</b>	
<b>SERIES NO</b>		
14064 Sgl., 4" Vent		\$1,412.00
14104 Sgl., 2" Vent		1,412.00
<b>ADD FOR OPTIONS:</b>		
-1 .....	\$80.00	-SD (500 lb.) .....
-6 .....	85.00	-SDH (750 lb.) .....
-6CU .....	85.00	-XSD (1000 lb.) .....
-45 .....	361.00	-VP .....
-46 .....	361.00	

	<b>VERTICAL CLOSE NO-HUB, OFFSET</b>	
	<b>LIST PRICE</b>	
<b>SERIES NO</b>		
14404 Sgl. L.H., L.H. 2" Vent		\$1,412.00
14424 Sgl. R.H., R.H. 2" Vent		1,412.00
14444 Back-to-Back, 2" Vent		2,417.00
<b>ADD FOR OPTIONS:</b>		
-1* .....	\$80.00	-30-2 .....
-6* .....	85.00	-50 .....
-6CU* .....	85.00	-54 .....
-10 .....	0.00	-SDH (750 lb.) .....
-24* .....	Deduct 155.00	-XSD (1000 lb.) .....
-30 .....	0.00	-VP* .....

\* Pricing for options is per fixture.  
Add or subtract twice for Back-to-Back Carriers

	<b>VERTICAL CLOSE NO-HUB, ON STACK</b>	
	<b>LIST PRICE</b>	
<b>SERIES NO</b>		
14464 Single, 4" Vent		\$1,412.00
14484 Back-to-Back, 4" Vent Siphon Jet Closets Only		2,497.00
<b>ADD FOR OPTIONS:</b>		
-1* .....	\$80.00	-45 .....
-6* .....	85.00	-46 .....
-6CU* .....	85.00	-SD (500 lb.)* .....
-10 .....	0.00	-SDH (750 lb.) .....
-24* .....	Deduct 155.00	-VP* .....
-30 .....	0.00	-XSD (1000 lb.) .....
-30-2 .....	0.00	

\* Pricing for options is per fixture.  
Add or subtract twice for Back-to-Back Carriers









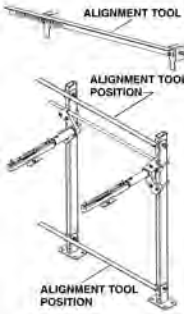

	<b>VERTICAL CLOSE NO-HUB, ON STACK</b>	
	<b>LIST PRICE</b>	
<b>SERIES NO</b>		
14504 Single, 2" Vent		\$1,412.00
<b>ADD FOR OPTIONS:</b>		
-1 .....	\$80.00	-45 .....
-6 .....	85.00	-46 .....
-6CU .....	85.00	-SD (500 lb.) .....
-10 .....	0.00	-SDH (750 lb.) .....
-24 .....	Deduct 155.00	-VP .....
-30 .....	0.00	-XSD (1000 lb.) .....
-30-2 .....	0.00	

	<b>90° INSTITUTIONAL FITTING VERTICAL NO-HUB, ON STACK</b>	
	<b>LIST PRICE</b>	
<b>SERIES NO</b>		
15964 Double Waste Fitting with Vent and Carriers		\$4,277.00
<b>ADD FOR OPTIONS:</b>		
-1 .....	\$158.00	-30-2 .....
-6 .....	169.00	-49 .....
-6CU .....	169.00	-54 .....
-10 .....	0.00	-VP .....
-24 .....	Deduct 155.00	-XSD (1000 lb.) .....
-26 .....	\$0.00	
-30 .....	0.00	

	<b>90° INSTITUTIONAL FITTING VERTICAL NO-HUB, ON STACK</b>	
	<b>LIST PRICE</b>	
<b>SERIES NO</b>		
15984 Double Waste Fitting, No-Hub Branches, 2" Vent		\$1,628.00
<b>ADD FOR OPTIONS:</b>		
-26 .....	\$0.00	-54 .....
-49 .....	361.00	

	<b>FLOOR-MOUNT PVC ADAPTER TYPE, ON STACK</b>	
	<b>LIST PRICE</b>	
<b>SERIES NO</b>		
16123 Single, for PVC Pipe Siphon Jet Closets Only		\$1,016.00
<b>ADD FOR OPTIONS:</b>		
-1 .....	\$80.00	-13 .....
-6 .....	85.00	-21 .....
		-VP .....

<b>Closet Carrier</b>	
<b>OPTION DESCRIPTIONS</b>	
-SD	Special-Duty 500 lb. Carrier
-SDH	Special-Duty 750 lb. Carrier
-XSD	Extra Special-Duty 1,000 lb. Carrier
-VP	Vandal-Proof Trim
-1	Positioning Frame
-6	Supply Pipe Support - Galvanized Pipe
-6CU	Supply Pipe Support - Copper Pipe
-10	ABS Extension through 10-1/2" Wall
-13	3" ABS Fitting Adapter
-21	Hanger Type Closet Adapter
-24	Carrier for Floor-Mounted, Back-Outlet China Bowls
-26	Fitting Anchor Foot
-30	Cast Iron Adjustable Extension with Connector
-30-2	Cast Iron Adjustable Extension with Connector and Test Cap
-45	Threaded Left-Hand Auxiliary Inlet
-46	Threaded Right-Hand Auxiliary Inlet
-49	No-Hub High Auxiliary Inlet, Under Vent
-50	No-Hub High Auxiliary Inlet, Opposite Vent
-54	Threaded High Auxiliary Inlet, Opposite Vent

 <p><b>17000</b></p>	<p align="center"><b>REUSABLE ALIGNMENT TOOL</b></p> <table border="1"> <thead> <tr> <th colspan="3">LIST PRICE</th> </tr> </thead> <tbody> <tr> <td>TYPE NO.</td> <td>17000</td> <td>\$266.00</td> </tr> </tbody> </table>	LIST PRICE			TYPE NO.	17000	\$266.00	 <p><b>17380</b></p>	<p align="center"><b>FLOOR-MOUNT ADJUSTABLE EXPOSED ARMS</b></p> <table border="1"> <thead> <tr> <th colspan="3">LIST PRICE</th> </tr> </thead> <tbody> <tr> <td>TYPE NO.</td> <td>17380</td> <td>17380-BB</td> </tr> <tr> <td></td> <td>\$1,397.00</td> <td>\$2,191.00</td> </tr> </tbody> </table> <p><b>ADD FOR OPTIONS:</b></p> <table border="1"> <thead> <tr> <th></th> <th>17380</th> <th>17380-BB</th> </tr> </thead> <tbody> <tr> <td>-10*</td> <td>\$47.00</td> <td>\$95.00</td> </tr> <tr> <td>-60</td> <td>145.00</td> <td>290.00</td> </tr> <tr> <td>-66**</td> <td>Deduct 132.00</td> <td>----</td> </tr> <tr> <td>-BB**</td> <td>794.00</td> <td>ABOVE</td> </tr> <tr> <td>-HD</td> <td>165.00</td> <td>330.00</td> </tr> <tr> <td>-VP</td> <td>130.00</td> <td>260.00</td> </tr> </tbody> </table> <p>* Hardware for Walls over 4-1/2", Specify Wall Thickness, Price Per Inch" ** -66 cannot be Furnished with -BB.</p>	LIST PRICE			TYPE NO.	17380	17380-BB		\$1,397.00	\$2,191.00		17380	17380-BB	-10*	\$47.00	\$95.00	-60	145.00	290.00	-66**	Deduct 132.00	----	-BB**	794.00	ABOVE	-HD	165.00	330.00	-VP	130.00	260.00													
LIST PRICE																																																				
TYPE NO.	17000	\$266.00																																																		
LIST PRICE																																																				
TYPE NO.	17380	17380-BB																																																		
	\$1,397.00	\$2,191.00																																																		
	17380	17380-BB																																																		
-10*	\$47.00	\$95.00																																																		
-60	145.00	290.00																																																		
-66**	Deduct 132.00	----																																																		
-BB**	794.00	ABOVE																																																		
-HD	165.00	330.00																																																		
-VP	130.00	260.00																																																		
 <p><b>17100</b></p>	<p align="center"><b>FLOOR-MOUNT ADJUSTABLE CONCEALED ARMS</b></p> <table border="1"> <thead> <tr> <th colspan="3">LIST PRICE</th> </tr> </thead> <tbody> <tr> <td>TYPE NO.</td> <td>17100</td> <td>17100-BB</td> </tr> <tr> <td></td> <td>\$979.00</td> <td>\$1,394.00</td> </tr> </tbody> </table> <p><b>ADD FOR OPTIONS:</b></p> <table border="1"> <thead> <tr> <th></th> <th>17100</th> <th>17100-BB</th> </tr> </thead> <tbody> <tr> <td>-10*</td> <td>\$47.00</td> <td>\$95.00</td> </tr> <tr> <td>-60</td> <td>145.00</td> <td>290.00</td> </tr> <tr> <td>-67</td> <td>66.00</td> <td>132.00</td> </tr> <tr> <td>-75</td> <td>161.00</td> <td>321.00</td> </tr> <tr> <td>-76</td> <td>293.00</td> <td>585.00</td> </tr> <tr> <td>-77</td> <td>293.00</td> <td>585.00</td> </tr> <tr> <td>-BB</td> <td>415.00</td> <td>ABOVE</td> </tr> </tbody> </table> <p>* Extension Sleeves Longer than 6-1/2", Specify Wall Thickness, Price Per Inch.</p>	LIST PRICE			TYPE NO.	17100	17100-BB		\$979.00	\$1,394.00		17100	17100-BB	-10*	\$47.00	\$95.00	-60	145.00	290.00	-67	66.00	132.00	-75	161.00	321.00	-76	293.00	585.00	-77	293.00	585.00	-BB	415.00	ABOVE	 <p><b>17390</b></p>	<p align="center"><b>WALL-MOUNT ADJUSTABLE EXPOSED ARMS</b></p> <table border="1"> <thead> <tr> <th colspan="3">LIST PRICE</th> </tr> </thead> <tbody> <tr> <td>TYPE NO.</td> <td>17390</td> <td>\$970.00</td> </tr> </tbody> </table> <p><b>ADD FOR OPTIONS:</b></p> <table border="1"> <tbody> <tr> <td>-10*.....</td> <td>\$47.00</td> <td>-BP.....</td> <td>\$0.00</td> <td>-VP.....</td> <td>\$130.00</td> </tr> </tbody> </table> <p>* Hardware for Walls over 4-1/2", Specify Wall Thickness, Price Per Inch</p>	LIST PRICE			TYPE NO.	17390	\$970.00	-10*.....	\$47.00	-BP.....	\$0.00	-VP.....	\$130.00				
LIST PRICE																																																				
TYPE NO.	17100	17100-BB																																																		
	\$979.00	\$1,394.00																																																		
	17100	17100-BB																																																		
-10*	\$47.00	\$95.00																																																		
-60	145.00	290.00																																																		
-67	66.00	132.00																																																		
-75	161.00	321.00																																																		
-76	293.00	585.00																																																		
-77	293.00	585.00																																																		
-BB	415.00	ABOVE																																																		
LIST PRICE																																																				
TYPE NO.	17390	\$970.00																																																		
-10*.....	\$47.00	-BP.....	\$0.00	-VP.....	\$130.00																																															
 <p><b>17120</b></p>	<p align="center"><b>WALL-MOUNT ADJUSTABLE CONCEALED ARMS</b></p> <table border="1"> <thead> <tr> <th colspan="3">LIST PRICE</th> </tr> </thead> <tbody> <tr> <td>TYPE NO.</td> <td>17120</td> <td>\$579.00</td> </tr> </tbody> </table> <p><b>ADD FOR OPTIONS:</b></p> <table border="1"> <tbody> <tr> <td>-10* .....</td> <td>\$47.00</td> <td>-BP .....</td> <td>\$0.00</td> </tr> <tr> <td>-75 .....</td> <td>161.00</td> <td>-MMB.....</td> <td>Deduct 121.00</td> </tr> <tr> <td>-76 .....</td> <td>293.00</td> <td></td> <td></td> </tr> <tr> <td>-77 .....</td> <td>293.00</td> <td></td> <td></td> </tr> </tbody> </table> <p>* Extension Sleeves Longer than 4", Specify Wall Thickness, Price Per Inch</p>	LIST PRICE			TYPE NO.	17120	\$579.00	-10* .....	\$47.00	-BP .....	\$0.00	-75 .....	161.00	-MMB.....	Deduct 121.00	-76 .....	293.00			-77 .....	293.00			 <p><b>17405</b></p>	<p align="center"><b>WALL-MOUNT EXPOSED ARMS ONLY</b></p> <table border="1"> <thead> <tr> <th colspan="3">LIST PRICE</th> </tr> </thead> <tbody> <tr> <td>TYPE NO.</td> <td>17405</td> <td>\$628.00</td> </tr> </tbody> </table> <p><b>ADD FOR OPTIONS:</b></p> <table border="1"> <tbody> <tr> <td>-10* .....</td> <td>\$47.00</td> <td>-VP.....</td> <td>\$130.00</td> </tr> </tbody> </table> <p>* Hardware for Walls over 4", Specify Wall Thickness, Price Per Inch</p>	LIST PRICE			TYPE NO.	17405	\$628.00	-10* .....	\$47.00	-VP.....	\$130.00																	
LIST PRICE																																																				
TYPE NO.	17120	\$579.00																																																		
-10* .....	\$47.00	-BP .....	\$0.00																																																	
-75 .....	161.00	-MMB.....	Deduct 121.00																																																	
-76 .....	293.00																																																			
-77 .....	293.00																																																			
LIST PRICE																																																				
TYPE NO.	17405	\$628.00																																																		
-10* .....	\$47.00	-VP.....	\$130.00																																																	
 <p><b>17125</b></p>	<p align="center"><b>WALL-MOUNT, NON-ADJUSTABLE CONCEALED ARMS</b></p> <table border="1"> <thead> <tr> <th colspan="3">LIST PRICE</th> </tr> </thead> <tbody> <tr> <td>TYPE NO.</td> <td>17125</td> <td>\$450.00</td> </tr> </tbody> </table> <p><b>ADD FOR OPTIONS:</b></p> <table border="1"> <tbody> <tr> <td>-10* .....</td> <td>\$47.00</td> <td>-75.....</td> <td>\$161.00</td> </tr> </tbody> </table> <p>* Extension Sleeves Longer than 4", Specify Wall Thickness, Price Per Inch</p>	LIST PRICE			TYPE NO.	17125	\$450.00	-10* .....	\$47.00	-75.....	\$161.00	 <p><b>17550</b></p>	<p align="center"><b>FLOOR-MOUNT HANGER PLATE TYPE</b></p> <table border="1"> <thead> <tr> <th colspan="4">LIST PRICE</th> </tr> </thead> <tbody> <tr> <td>17550</td> <td>17550-BB</td> <td>17550-UR</td> <td>17550-WCBL</td> </tr> <tr> <td>\$741.00</td> <td>\$979.00</td> <td>\$741.00</td> <td>\$1,212.00</td> </tr> </tbody> </table> <p><b>ADD FOR OPTIONS:</b></p> <table border="1"> <thead> <tr> <th></th> <th>17550</th> <th>17550-BB</th> </tr> </thead> <tbody> <tr> <td>-10*</td> <td>\$47.00</td> <td>\$95.00</td> </tr> <tr> <td>-60</td> <td>145.00</td> <td>290.00</td> </tr> <tr> <td>-BB</td> <td>238.00</td> <td>ABOVE</td> </tr> <tr> <td>-CL</td> <td>305.00</td> <td>----</td> </tr> <tr> <td>-UR**</td> <td>0.00</td> <td>----</td> </tr> <tr> <td>-WC**</td> <td>0.00</td> <td>----</td> </tr> <tr> <td>-WCBL**</td> <td>471.00</td> <td>----</td> </tr> </tbody> </table> <p>* Hardware for Walls over 4", Specify Wall Thickness, Price Per Inch ** Cannot be Furnished with -60</p>	LIST PRICE				17550	17550-BB	17550-UR	17550-WCBL	\$741.00	\$979.00	\$741.00	\$1,212.00		17550	17550-BB	-10*	\$47.00	\$95.00	-60	145.00	290.00	-BB	238.00	ABOVE	-CL	305.00	----	-UR**	0.00	----	-WC**	0.00	----	-WCBL**	471.00	----			
LIST PRICE																																																				
TYPE NO.	17125	\$450.00																																																		
-10* .....	\$47.00	-75.....	\$161.00																																																	
LIST PRICE																																																				
17550	17550-BB	17550-UR	17550-WCBL																																																	
\$741.00	\$979.00	\$741.00	\$1,212.00																																																	
	17550	17550-BB																																																		
-10*	\$47.00	\$95.00																																																		
-60	145.00	290.00																																																		
-BB	238.00	ABOVE																																																		
-CL	305.00	----																																																		
-UR**	0.00	----																																																		
-WC**	0.00	----																																																		
-WCBL**	471.00	----																																																		
 <p><b>17125-UP-ADJ</b></p>	<p align="center"><b>PRE-ASSEMBLED CARRIER, FLOOR-MOUNT ADJUSTABLE CONCEALED ARMS</b></p> <table border="1"> <thead> <tr> <th colspan="3">LIST PRICE</th> </tr> </thead> <tbody> <tr> <td>TYPE NO.</td> <td>17125-UP-ADJ</td> <td>\$1,275.00</td> </tr> </tbody> </table> <p><b>ADD FOR OPTIONS:</b></p> <table border="1"> <tbody> <tr> <td>-10* .....</td> <td>\$47.00</td> <td>-75.....</td> <td>\$161.00</td> </tr> </tbody> </table> <p>* Extension Sleeves Longer than 4", Specify Wall Thickness, Price Per Inch</p>	LIST PRICE			TYPE NO.	17125-UP-ADJ	\$1,275.00	-10* .....	\$47.00	-75.....	\$161.00	<p><b>Fixture Carrier OPTION DESCRIPTIONS</b></p> <table border="0"> <tbody> <tr> <td>-BB</td> <td>Back-to-Back Carrier</td> <td>-60</td> <td>Valve Plate for Attaching to Upright</td> </tr> <tr> <td>-BP</td> <td>with Back Plates</td> <td>-66</td> <td>Split Header for Stainless Steel Arms</td> </tr> <tr> <td>-CL</td> <td>Corner Lavatory Carrier</td> <td>-67</td> <td>Concealed Arm Carrier for Wheelchair Lavatory</td> </tr> <tr> <td>-HD</td> <td>Heavy-Duty</td> <td>-75</td> <td>2" Chrome Plated Escutcheons</td> </tr> <tr> <td>-MMB</td> <td>with Movable Mounting Brackets</td> <td>-76</td> <td>4" Chrome Plated Escutcheons</td> </tr> <tr> <td>-UR</td> <td>Urinal Carrier</td> <td>-77</td> <td>6" Chrome Plated Escutcheons</td> </tr> <tr> <td>-VP</td> <td>Vandal-Proof Trim</td> <td></td> <td></td> </tr> <tr> <td>-WC</td> <td>Water Cooler Carrier</td> <td></td> <td></td> </tr> <tr> <td>-WCBL</td> <td>Water Cooler Bi-Level Carrier</td> <td></td> <td></td> </tr> <tr> <td>-10</td> <td>Extension Sleeves or Hardware for Thicker Walls, See Product</td> <td></td> <td></td> </tr> </tbody> </table>	-BB	Back-to-Back Carrier	-60	Valve Plate for Attaching to Upright	-BP	with Back Plates	-66	Split Header for Stainless Steel Arms	-CL	Corner Lavatory Carrier	-67	Concealed Arm Carrier for Wheelchair Lavatory	-HD	Heavy-Duty	-75	2" Chrome Plated Escutcheons	-MMB	with Movable Mounting Brackets	-76	4" Chrome Plated Escutcheons	-UR	Urinal Carrier	-77	6" Chrome Plated Escutcheons	-VP	Vandal-Proof Trim			-WC	Water Cooler Carrier			-WCBL	Water Cooler Bi-Level Carrier			-10	Extension Sleeves or Hardware for Thicker Walls, See Product		
LIST PRICE																																																				
TYPE NO.	17125-UP-ADJ	\$1,275.00																																																		
-10* .....	\$47.00	-75.....	\$161.00																																																	
-BB	Back-to-Back Carrier	-60	Valve Plate for Attaching to Upright																																																	
-BP	with Back Plates	-66	Split Header for Stainless Steel Arms																																																	
-CL	Corner Lavatory Carrier	-67	Concealed Arm Carrier for Wheelchair Lavatory																																																	
-HD	Heavy-Duty	-75	2" Chrome Plated Escutcheons																																																	
-MMB	with Movable Mounting Brackets	-76	4" Chrome Plated Escutcheons																																																	
-UR	Urinal Carrier	-77	6" Chrome Plated Escutcheons																																																	
-VP	Vandal-Proof Trim																																																			
-WC	Water Cooler Carrier																																																			
-WCBL	Water Cooler Bi-Level Carrier																																																			
-10	Extension Sleeves or Hardware for Thicker Walls, See Product																																																			
 <p><b>17140</b></p>	<p align="center"><b>NON-ADJUSTABLE, CONCEALED ARMS WITH WELDED SLEEVES FOR BLOCK WALL MOUNT</b></p> <table border="1"> <thead> <tr> <th colspan="3">LIST PRICE</th> </tr> </thead> <tbody> <tr> <td>TYPE NO.</td> <td>17140</td> <td>\$455.00</td> </tr> </tbody> </table> <p><b>ADD FOR OPTIONS:</b></p> <table border="1"> <tbody> <tr> <td>-75.....</td> <td>\$161.00</td> <td></td> <td></td> </tr> </tbody> </table>	LIST PRICE			TYPE NO.	17140	\$455.00	-75.....	\$161.00																																											
LIST PRICE																																																				
TYPE NO.	17140	\$455.00																																																		
-75.....	\$161.00																																																			

**17560**



**FLOOR-MOUNT BEARING PLATE TYPE**

LIST PRICE			
17560	17560-BB	17560-UR 17560-WC	17560- WCBL
\$826.00	\$1,154.00	\$826.00	\$1,207.00

**ADD FOR OPTIONS:**

	17560	17560-BB
-10*	\$47.00	\$95.00
-60	145.00	290.00
-BB	328.00	ABOVE
-UR**	0.00	----
-WC**	0.00	----
-WCBL**	381.00	----

\* Hardware for Walls over 4",  
Specify Wall Thickness, Price Per Inch  
\*\* Cannot be Furnished with -60

**17590**

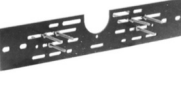

**WALL-MOUNT HANGER PLATE TYPE**

LIST PRICE		
17590	17590-DP	17590-UR
\$205.00	\$252.00	\$205.00

**ADD FOR OPTIONS:**

-10*.....	\$47.00	-DP.....	\$47.00
		-UR.....	0.00

\* Hardware for Walls over 7" for 17590 or 4" for 17590-DP and 17590  
-UR-DP, Specify Wall Thickness, Price Per Inch

**17720**



**FLOOR-MOUNT HEAVY-DUTY TYPE**

LIST PRICE		
TYPE NO.	17720	\$2,514.00

**ADD FOR OPTIONS:**

-10*.....	\$98.00	-VP.....	\$130.00
-66.....	Ded. 145.00		

\* Hardware for Walls over 4",  
Specify Wall Thickness, Price Per Inch

**17730**



**FLOOR-MOUNT WITH ADJUSTABLE COUPLING**

LIST PRICE		
TYPE NO.	17730	\$1,184.00

**ADD FOR OPTIONS:**

-11.....	\$0.00	-VP.....	\$130.00
-60.....	145.00		

**17735**

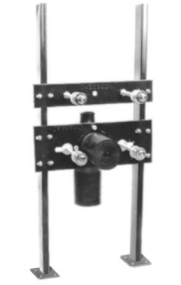

**FLOOR-MOUNT WITH FITTING**

LIST PRICE		
TYPE NO.	17735	\$1,960.00

**ADD FOR OPTIONS:**

-10*.....	\$0.00	-46.....	\$361.00
-45.....	361.00	-VP.....	130.00

\* Hardware for Walls over 5-3/8",  
Specify Wall Thickness, Price Per Inch  
NOTE: Other Fittings Available on Request.  
Contact your Josam Representative.

**Fixture Carrier  
OPTION DESCRIPTIONS**

- BB Back-to-Back Carrier
- DP Double Plate Carrier
- UR Urinal Carrier
- VP Vandal-Proof Trim
- WC Water Cooler Carrier
- WCBL Water Cooler Bi-Level Carrier
- 10 Hardware for Thicker Walls
- 11 Cast Iron Adjustable Extension through 12" Length, Specify 6", 9" or 12" on Order
- 45 Threaded High Left-Hand Auxiliary Vent
- 46 Threaded High Right-Hand Auxiliary Vent
- 60 Valve Plate for Attaching to Upright
- 66 Split Header for Stainless Steel Arms

**ROOF DRAINS**

**21500**



**15" DOME, LARGE SUMP**

PIPE SIZE	LIST PRICE			
	21500	21500-AE	21500-16	21500-AE-16
2", 3", 4"	\$702.00	\$1,404.00	\$1,118.00	\$1,820.00
5", 6"	1,003.00	1,705.00	1,419.00	2,121.00
8"	1,302.00	2,004.00	1,718.00	N/A
10"	2,054.00	2,756.00	N/A	N/A

**ADD FOR OPTIONS:**

-1.....	\$240.00	-19.....	\$778.00	-AER.....	\$323.00
-2.....	270.00	-20.....	950.00	-ARE.....	1,349.00
-3.....	509.00	-21.....	409.00	-IRMA.....	778.00
-3C.....	365.00	-22.....	207.00	-CR.....	414.00
-4.....	185.00	-21-22.....	616.00	-FG.....	572.00
-6.....	1,306.00	-23.....	823.00	-OR.....	702.00
-10**.....	656.00	-26.....	243.00	-T.....	77.00
-10-20**.....	1,038.00	-33.....	496.00	-VP.....	123.00
-16◇.....	416.00	-66.....	367.00	-X.....	0.00
-17◇.....	227.00	-AE.....	702.00	-Y.....	0.00
				-Z.....	0.00

\* Minimum Deck Opening 16.5" Dia.  
\*\* Specify Height, Price Each 4" or Fraction  
◇ -16 and -17 cannot be furnished together

**GREEN ROOF DRAINS**

**21500-RDG**

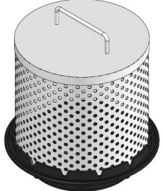

PIPE SIZE	LIST PRICE			
	21500-RDG1	21500-RDG2	21500-RDG3	21500-ORDG1
2", 3", 4"	\$3,820.00	\$3,604.00	\$3,708.00	\$3,820.00
5", 6"	4,121.00	3,903.00	4,008.00	4,121.00
8"	4,421.00	4,203.00	4,309.00	4,421.00

**ADD FOR OPTIONS:**

-1.....	\$240.00	-21.....	\$409.00	-CR.....	\$414.00
-2.....	270.00	-23.....	823.00	-OR.....	702.00
-3.....	509.00	-26.....	243.00	-PC.....	0.00
-3C.....	365.00	-20.....	950.00	-T.....	77.00
-4.....	185.00	-33.....	496.00	-VP.....	123.00
-6.....	1,306.00	-66.....	367.00	-X.....	0.00
-10**.....	656.00	-AE.....	702.00	-Y.....	0.00
-10-20**.....	1,038.00	-AER.....	323.00	-Z.....	0.00
-17.....	227.00	-AI.....	886.00		
-22.....	207.00	-ARE.....	1,349.00		

\* Minimum Deck Opening 16.5" Dia.  
\*\* Specify Height, Price Each 4" or Fraction





	<b>12" BEEHIVE DOME, MEDIUM SUMP</b>		
	LIST PRICE		
	PIPE SIZE	2" - 6"	\$620.00
ADD FOR OPTIONS:			
-1 .....	\$147.00	-19 .....	\$620.00
-2 .....	255.00	-20 .....	388.00
-3 .....	403.00	-21 .....	157.00
-3C .....	351.00	-23 .....	403.00
-10** .....	87.00	-26 .....	178.00
-10-20** .....	172.00	-66 .....	157.00
-17 .....	187.00	-AER .....	501.00
-ARE .....		-X .....	0.00
-Z .....		-T .....	77.00
-FG .....		-VP .....	112.00
-IRMA .....		-Y .....	0.00
-IRMA .....		-Z .....	0.00
<ul style="list-style-type: none"> <li>• Price up to 4". Each additional inch, add \$75.00.</li> <li>* Minimum Deck Opening 13.75" Dia.</li> <li>** Specify Height, Price Per Inch</li> </ul>			

	<b>9" HIGH DOME, SMALL SUMP</b>		
	LIST PRICE		
	PIPE SIZE	2", 3", 4"	\$523.00
ADD FOR OPTIONS:			
-1 .....	\$147.00	-20 .....	\$199.00
-2 .....	255.00	-21 .....	79.00
-3 .....	403.00	-23 .....	329.00
-3C .....	336.00	-26 .....	178.00
-10** .....	87.00	-33 .....	298.00
-10-20** .....	172.00	-66 .....	153.00
-17 .....	187.00	-AER .....	501.00
-19 .....	460.00	-ARE .....	759.00
-Z .....		-X .....	0.00
-Y .....		-Z .....	0.00
-T .....		-Y .....	0.00
-FG .....		-Z .....	0.00
-IRMA .....		-Z .....	0.00
-TSO .....		-Z .....	0.00
-VP .....		-Z .....	0.00
<ul style="list-style-type: none"> <li>• Price up to 4". Each additional inch, add \$75.00.</li> <li>◇ Cannot be used with Drain Receiver</li> <li>* Minimum Deck Opening 10.75" Dia.</li> <li>** Specify Height, Price Per Inch</li> </ul>			

	<b>COMBINATION DRAIN/OVERFLOW, SMALL SUMP WITH CI DOME</b>		
	LIST PRICE		
	PIPE SIZE	2", 3", 4"	\$722.00
ADD FOR OPTIONS:			
-1 .....	\$341.00	-23 .....	\$329.00
-10* .....	172.00	-33 .....	557.00
-20 .....	396.00	-IRMA .....	915.00
-VP .....		-Z .....	0.00
* Specify Height, Price Per Inch			













	<b>COMBINATION DRAIN/OVERFLOW, MEDIUM SUMP WITH CI DOME</b>		
	LIST PRICE		
	PIPE SIZE	2" - 6"	\$1,927.00
ADD FOR OPTIONS:			
-10* .....	\$172.00	-33 .....	\$926.00
-10-20* .....	353.00	-66 .....	153.00
-20 .....	774.00	-IRMA .....	1,240.00
-23 .....	806.00	-RCSD .....	\$0.00
-T .....		-Z .....	0.00
-VP .....		-Z .....	0.00
* Specify Height, Price Per Inch			









	<b>COMBINATION DRAIN/OVERFLOW, LARGE SUMP AND POLY DOME</b>		
	LIST PRICE		
	PIPE SIZE	2", 3", 4"	5", 6"
	\$2,468.00	\$3,069.00	\$3,669.00
ADD FOR OPTIONS:			
-1 .....	\$481.00	-23 .....	\$1,646.00
-4 .....	370.00	-26 .....	487.00
-10* .....	1,309.00	-33 .....	996.00
-10-20 .....	*2,078.00	-66 .....	735.00
-20 .....	1,899.00	-AE .....	1,410.00
-21 .....	724.00	-IRMA .....	1,563.00
-22 .....	414.00	-RCSD .....	\$0.00
-VP .....		-Z .....	0.00
-T .....		-Z .....	0.00
-Y .....		-Z .....	0.00
-Z .....		-Z .....	0.00
* Specify Height, Price Each 4" or Fraction			









	<b>14" PROMENADE TOP, LARGE SUMP</b>				
	LIST PRICE				
	PIPE SIZE	23500	23500-AE	23500-6	23500-IRMA
2", 3", 4"	\$1,194.00	\$1,895.00	\$2,499.00	\$1,972.00	
5", 6"	1,474.00	2,176.00	2,780.00	2,252.00	
8"	1,750.00	2,452.00	N/A	2,528.00	
10"	2,338.00	3,040.00	N/A	3,116.00	
ADD FOR OPTIONS:					
-1 .....	\$240.00	-20 .....	\$880.00	-CR .....	\$414.00
-2 .....	270.00	-36 .....	609.00	-IRMA .....	778.00
-3 .....	509.00	-37-50 .....	1,606.00	-PG .....	771.00
-3C .....	365.00	-37-51 .....	1,415.00	-VP .....	144.00
-4 .....	185.00	-50 .....	992.00	-T .....	77.00
-6 .....	1,306.00	-51 .....	811.00	-X .....	0.00
-10** .....	656.00	-66 .....	367.00	-Y .....	0.00
-10-20** .....	1,038.00	-AE .....	702.00	-Z .....	0.00
-18 .....	587.00	-ARE .....	1,613.00		
* Minimum Deck Opening 16.5" Dia.					
** Specify Height, Price Each 4" or Fraction					









## Roof Drain OPTION DESCRIPTIONS

- AE LEVELEZE® Adjustable Extension
- AER Adjustable Extension using Threaded Rods and Hardware
- ARE Acid-Resisting Epoxy
- CR Clamping Drain Receiver
- FG Flat Cast Iron Grate
- IRMA Perforated Stainless Steel Extension
- OR LEVELEZE® Adjustable Extension with O-Ring
- PC Perforated Cover
- PG Parking Grate
- Q244 Flat Cast Iron Plaza Grate
- Q28 Flat Cast Iron Heavy Duty Grate
- RCSD Recessed Drain Receiver
- VP Vandal-Proof Dome or Grate
- 1 Deck Clamp Assembly
- 2 Drain Receiver
- 3 Deck Clamp Assembly and Drain Receiver
- 3C Drain Receiver and Drain Receiver Clips
- 4 Secondary Flashing Clamp (use with -AE Only)
- 6 Extra Wide Flange Drain Body (2" through 6", -X Only)
- 10 Fixed Extended Collar, Cast Iron
- 10-20 Fixed Extended Collar, Galvanized
- 16 Internal Water Guard 2-6" Outlets Only
- 17 2" High Solid Clamping Collar
- 18 Extra Deep Sump
- 19 Clamp Collar w/Perforated SS Gravel Guard
- 20 Galvanized Cast Iron Parts
- 21 Galvanized Cast Iron Dome Only
- 22 Cast Iron Dome
- 23 Rough Bronze Dome
- 26 Aluminum Dome
- 33 Stainless Mesh Screen-Covered Dome
- 36 Ductile Iron Grate (Cast Iron Top Only)
- 37-50 HD Ductile Iron Undergrate Laminated Top, Satin Finish Nikaloy
- 37-51 HD Ductile Iron Undergrate Laminated Top, Satin Finish Bronze
- 50 C.I. Undergrate Laminated Top, Satin Finish Nikaloy
- 51 C.I. Undergrate Laminated Top, Satin Finish Bronze
- Outlets**
- 66 No-Hub Side Outlet, 2" - 6"
- T Threaded Outlet
- TSO Threaded Side Outlet
- X Inside Caulk Outlet
- Y Hub Outlet w/Gasket, 2" - 4"
- Z No-Hub Spigot Outlet

 <p><b>23510</b></p>	<p><b>15" EXTRA HEAVY-DUTY PARKING GRATE, LARGE SUMP</b></p> <table border="1"> <thead> <tr> <th colspan="4">LIST PRICE</th> </tr> <tr> <th>PIPE SIZE</th> <th>2", 3", 4"</th> <th>5", 6"</th> <th>8"</th> </tr> </thead> <tbody> <tr> <td></td> <td>\$1,547.00</td> <td>\$1,834.00</td> <td>\$2,189.00</td> </tr> </tbody> </table> <p><b>ADD FOR OPTIONS:</b></p> <table> <tr> <td>-1 .....</td><td>\$240.00</td> <td>-20 .....</td><td>\$880.00</td> <td>-T .....</td><td>\$77.00</td> </tr> <tr> <td>-2 .....</td><td>270.00</td> <td>-36 .....</td><td>607.00</td> <td>-VP .....</td><td>143.00</td> </tr> <tr> <td>-3 .....</td><td>509.00</td> <td>-50 .....</td><td>2,549.00</td> <td>-X .....</td><td>0.00</td> </tr> <tr> <td>-3C .....</td><td>365.00</td> <td>-51 .....</td><td>2,289.00</td> <td>-Y .....</td><td>0.00</td> </tr> <tr> <td>-10** .....</td><td>702.00</td> <td>-66 .....</td><td>367.00</td> <td>-Z .....</td><td>0.00</td> </tr> <tr> <td>-10-20** .....</td><td>990.00</td> <td>-CR .....</td><td>414.00</td> <td></td><td></td> </tr> </table> <p>* Minimum Deck Opening 16.5" Dia. ** Specify Height, Price Each 4" or Fraction</p>	LIST PRICE				PIPE SIZE	2", 3", 4"	5", 6"	8"		\$1,547.00	\$1,834.00	\$2,189.00	-1 .....	\$240.00	-20 .....	\$880.00	-T .....	\$77.00	-2 .....	270.00	-36 .....	607.00	-VP .....	143.00	-3 .....	509.00	-50 .....	2,549.00	-X .....	0.00	-3C .....	365.00	-51 .....	2,289.00	-Y .....	0.00	-10** .....	702.00	-66 .....	367.00	-Z .....	0.00	-10-20** .....	990.00	-CR .....	414.00			 <p><b>24030</b></p>	<p><b>13" SUPER-FLO® TOP, MEDIUM SUMP COMPOSITION DECK FLANGE</b></p> <table border="1"> <thead> <tr> <th colspan="3">LIST PRICE</th> </tr> <tr> <th>PIPE SIZE</th> <th>4", 5", 6", 8"</th> <th></th> </tr> </thead> <tbody> <tr> <td></td> <td></td> <td>\$1,763.00</td> </tr> </tbody> </table> <p><b>ADD FOR OPTIONS:</b></p> <table> <tr> <td>-1 .....</td><td>\$223.00</td> <td>-31 .....</td><td>\$112.00</td> <td>-66 .....</td><td>\$153.00</td> </tr> <tr> <td>-20 .....</td><td>791.00</td> <td>-36 .....</td><td>260.00</td> <td>-HP .....</td><td>106.00</td> </tr> <tr> <td>-29 .....</td><td>239.00</td> <td>-50 .....</td><td>715.00</td> <td>-VP .....</td><td>146.00</td> </tr> <tr> <td>-29-20 .....</td><td>437.00</td> <td>-51 .....</td><td>651.00</td> <td>-X .....</td><td>0.00</td> </tr> </table>	LIST PRICE			PIPE SIZE	4", 5", 6", 8"				\$1,763.00	-1 .....	\$223.00	-31 .....	\$112.00	-66 .....	\$153.00	-20 .....	791.00	-36 .....	260.00	-HP .....	106.00	-29 .....	239.00	-50 .....	715.00	-VP .....	146.00	-29-20 .....	437.00	-51 .....	651.00	-X .....	0.00			
LIST PRICE																																																																																							
PIPE SIZE	2", 3", 4"	5", 6"	8"																																																																																				
	\$1,547.00	\$1,834.00	\$2,189.00																																																																																				
-1 .....	\$240.00	-20 .....	\$880.00	-T .....	\$77.00																																																																																		
-2 .....	270.00	-36 .....	607.00	-VP .....	143.00																																																																																		
-3 .....	509.00	-50 .....	2,549.00	-X .....	0.00																																																																																		
-3C .....	365.00	-51 .....	2,289.00	-Y .....	0.00																																																																																		
-10** .....	702.00	-66 .....	367.00	-Z .....	0.00																																																																																		
-10-20** .....	990.00	-CR .....	414.00																																																																																				
LIST PRICE																																																																																							
PIPE SIZE	4", 5", 6", 8"																																																																																						
		\$1,763.00																																																																																					
-1 .....	\$223.00	-31 .....	\$112.00	-66 .....	\$153.00																																																																																		
-20 .....	791.00	-36 .....	260.00	-HP .....	106.00																																																																																		
-29 .....	239.00	-50 .....	715.00	-VP .....	146.00																																																																																		
-29-20 .....	437.00	-51 .....	651.00	-X .....	0.00																																																																																		
 <p><b>23710</b></p>	<p><b>11" PROMENADE TOP, MEDIUM SUMP</b></p> <table border="1"> <thead> <tr> <th colspan="3">LIST PRICE</th> </tr> <tr> <th>PIPE SIZE</th> <th>2" - 6"</th> <th></th> </tr> </thead> <tbody> <tr> <td></td> <td></td> <td>\$1,068.00</td> </tr> </tbody> </table> <p><b>ADD FOR OPTIONS:</b></p> <table> <tr> <td>-1 .....</td><td>\$147.00</td> <td>-20 .....</td><td>\$495.00</td> <td>-T .....</td><td>\$77.00</td> </tr> <tr> <td>-2 .....</td><td>249.00</td> <td>-50 .....</td><td>730.00</td> <td>-VP .....</td><td>143.00</td> </tr> <tr> <td>-3 .....</td><td>396.00</td> <td>-51 .....</td><td>635.00</td> <td>-X .....</td><td>0.00</td> </tr> <tr> <td>-3C .....</td><td>344.00</td> <td>-66 .....</td><td>153.00</td> <td>-Z .....</td><td>0.00</td> </tr> <tr> <td>-12** .....</td><td>87.00</td> <td>-IRMA• .....</td><td>460.00</td> <td></td><td></td> </tr> </table> <p>• Price up to 4". Each additional inch, add \$75.00. * Minimum Deck Opening 13.75" Dia. ** Specify Height, Price Per Inch</p>	LIST PRICE			PIPE SIZE	2" - 6"				\$1,068.00	-1 .....	\$147.00	-20 .....	\$495.00	-T .....	\$77.00	-2 .....	249.00	-50 .....	730.00	-VP .....	143.00	-3 .....	396.00	-51 .....	635.00	-X .....	0.00	-3C .....	344.00	-66 .....	153.00	-Z .....	0.00	-12** .....	87.00	-IRMA• .....	460.00			 <p><b>24040</b></p>	<p><b>9" SUPER-FLO® TOP, MEDIUM SUMP COMPOSITION DECK FLANGE</b></p> <table border="1"> <thead> <tr> <th colspan="3">LIST PRICE</th> </tr> <tr> <th>PIPE SIZE</th> <th>2", 3", 4"</th> <th></th> </tr> </thead> <tbody> <tr> <td></td> <td></td> <td>\$998.00</td> </tr> </tbody> </table> <p><b>ADD FOR OPTIONS:</b></p> <table> <tr> <td>-1 .....</td><td>\$147.00</td> <td>-36 .....</td><td>\$207.00</td> <td>-HP .....</td><td>\$106.00</td> </tr> <tr> <td>-20 .....</td><td>595.00</td> <td>-38 .....</td><td>Deduct 88.00</td> <td>-VP .....</td><td>146.00</td> </tr> <tr> <td>-29 .....</td><td>136.00</td> <td>-50 .....</td><td>496.00</td> <td>-X .....</td><td>0.00</td> </tr> <tr> <td>-29-20 .....</td><td>205.00</td> <td>-51 .....</td><td>409.00</td> <td></td><td></td> </tr> <tr> <td>-31 .....</td><td>112.00</td> <td>-66 .....</td><td>153.00</td> <td></td><td></td> </tr> </table>	LIST PRICE			PIPE SIZE	2", 3", 4"				\$998.00	-1 .....	\$147.00	-36 .....	\$207.00	-HP .....	\$106.00	-20 .....	595.00	-38 .....	Deduct 88.00	-VP .....	146.00	-29 .....	136.00	-50 .....	496.00	-X .....	0.00	-29-20 .....	205.00	-51 .....	409.00			-31 .....	112.00	-66 .....	153.00								
LIST PRICE																																																																																							
PIPE SIZE	2" - 6"																																																																																						
		\$1,068.00																																																																																					
-1 .....	\$147.00	-20 .....	\$495.00	-T .....	\$77.00																																																																																		
-2 .....	249.00	-50 .....	730.00	-VP .....	143.00																																																																																		
-3 .....	396.00	-51 .....	635.00	-X .....	0.00																																																																																		
-3C .....	344.00	-66 .....	153.00	-Z .....	0.00																																																																																		
-12** .....	87.00	-IRMA• .....	460.00																																																																																				
LIST PRICE																																																																																							
PIPE SIZE	2", 3", 4"																																																																																						
		\$998.00																																																																																					
-1 .....	\$147.00	-36 .....	\$207.00	-HP .....	\$106.00																																																																																		
-20 .....	595.00	-38 .....	Deduct 88.00	-VP .....	146.00																																																																																		
-29 .....	136.00	-50 .....	496.00	-X .....	0.00																																																																																		
-29-20 .....	205.00	-51 .....	409.00																																																																																				
-31 .....	112.00	-66 .....	153.00																																																																																				
 <p><b>23730</b></p>	<p><b>9" PROMENADE TOP, SMALL SUMP</b></p> <table border="1"> <thead> <tr> <th colspan="3">LIST PRICE</th> </tr> <tr> <th>PIPE SIZE</th> <th>2", 3", 4"</th> <th></th> </tr> </thead> <tbody> <tr> <td></td> <td></td> <td>\$812.00</td> </tr> </tbody> </table> <p><b>ADD FOR OPTIONS:</b></p> <table> <tr> <td>-1 .....</td><td>\$147.00</td> <td>-20 .....</td><td>\$264.00</td> <td>-TSO ◊ .....</td><td>\$184.00</td> </tr> <tr> <td>-2 .....</td><td>249.00</td> <td>-50 .....</td><td>424.00</td> <td>-VP .....</td><td>143.00</td> </tr> <tr> <td>-3 .....</td><td>396.00</td> <td>-51 .....</td><td>378.00</td> <td>-X .....</td><td>0.00</td> </tr> <tr> <td>-3C .....</td><td>329.00</td> <td>-66 .....</td><td>153.00</td> <td>-Y .....</td><td>0.00</td> </tr> <tr> <td>-12** .....</td><td>87.00</td> <td>-IRMA• .....</td><td>460.00</td> <td>-Z .....</td><td>0.00</td> </tr> <tr> <td>-12-20** .....</td><td>172.00</td> <td>-T .....</td><td>77.00</td> <td></td><td></td> </tr> </table> <p>• Price up to 4". Each additional inch, add \$75.00. ◊ Cannot be used with Drain Receiver * Minimum Deck Opening 10.25" Dia. ** Specify Height, Price Per Inch</p>	LIST PRICE			PIPE SIZE	2", 3", 4"				\$812.00	-1 .....	\$147.00	-20 .....	\$264.00	-TSO ◊ .....	\$184.00	-2 .....	249.00	-50 .....	424.00	-VP .....	143.00	-3 .....	396.00	-51 .....	378.00	-X .....	0.00	-3C .....	329.00	-66 .....	153.00	-Y .....	0.00	-12** .....	87.00	-IRMA• .....	460.00	-Z .....	0.00	-12-20** .....	172.00	-T .....	77.00			 <p><b>24050</b></p>	<p><b>GARAGE DRAIN, 13" SPECIAL-DUTY TOP, WIDE FLANGE</b></p> <table border="1"> <thead> <tr> <th colspan="3">LIST PRICE</th> </tr> <tr> <th>PIPE SIZE</th> <th>4", 6"</th> <th>8"</th> </tr> </thead> <tbody> <tr> <td></td> <td>\$2,506.00</td> <td>\$2,801.00</td> </tr> </tbody> </table> <p><b>ADD FOR OPTIONS:</b></p> <table> <tr> <td>-1 .....</td><td>\$223.00</td> <td>-29-20 .....</td><td>\$441.00</td> <td>-51 .....</td><td>\$1,068.00</td> </tr> <tr> <td>-12* .....</td><td>87.00</td> <td>-31 .....</td><td>112.00</td> <td>-66 .....</td><td>153.00</td> </tr> <tr> <td>-20 .....</td><td>1,078.00</td> <td>-36 .....</td><td>260.00</td> <td>-HP .....</td><td>106.00</td> </tr> <tr> <td>-29 .....</td><td>205.00</td> <td>-50 .....</td><td>1,301.00</td> <td>-VP .....</td><td>146.00</td> </tr> <tr> <td></td><td></td><td></td><td></td> <td>-X .....</td><td>0.00</td> </tr> </table> <p>* Specify Height, Price Per Inch</p>	LIST PRICE			PIPE SIZE	4", 6"	8"		\$2,506.00	\$2,801.00	-1 .....	\$223.00	-29-20 .....	\$441.00	-51 .....	\$1,068.00	-12* .....	87.00	-31 .....	112.00	-66 .....	153.00	-20 .....	1,078.00	-36 .....	260.00	-HP .....	106.00	-29 .....	205.00	-50 .....	1,301.00	-VP .....	146.00					-X .....	0.00
LIST PRICE																																																																																							
PIPE SIZE	2", 3", 4"																																																																																						
		\$812.00																																																																																					
-1 .....	\$147.00	-20 .....	\$264.00	-TSO ◊ .....	\$184.00																																																																																		
-2 .....	249.00	-50 .....	424.00	-VP .....	143.00																																																																																		
-3 .....	396.00	-51 .....	378.00	-X .....	0.00																																																																																		
-3C .....	329.00	-66 .....	153.00	-Y .....	0.00																																																																																		
-12** .....	87.00	-IRMA• .....	460.00	-Z .....	0.00																																																																																		
-12-20** .....	172.00	-T .....	77.00																																																																																				
LIST PRICE																																																																																							
PIPE SIZE	4", 6"	8"																																																																																					
	\$2,506.00	\$2,801.00																																																																																					
-1 .....	\$223.00	-29-20 .....	\$441.00	-51 .....	\$1,068.00																																																																																		
-12* .....	87.00	-31 .....	112.00	-66 .....	153.00																																																																																		
-20 .....	1,078.00	-36 .....	260.00	-HP .....	106.00																																																																																		
-29 .....	205.00	-50 .....	1,301.00	-VP .....	146.00																																																																																		
				-X .....	0.00																																																																																		
 <p><b>23740</b></p>	<p><b>8" HEAVY-DUTY TOP, MEDIUM SUMP</b></p> <table border="1"> <thead> <tr> <th colspan="3">LIST PRICE</th> </tr> <tr> <th>PIPE SIZE</th> <th>2", 3", 4"</th> <th></th> </tr> </thead> <tbody> <tr> <td></td> <td></td> <td>\$2,066.00</td> </tr> </tbody> </table> <p><b>ADD FOR OPTIONS:</b></p> <table> <tr> <td>-1 .....</td><td>\$147.00</td> <td>-20 .....</td><td>\$283.00</td> <td>-VP .....</td><td>\$143.00</td> </tr> <tr> <td>-2 .....</td><td>249.00</td> <td>-51 .....</td><td>Deduct 99.00</td> <td>-X .....</td><td>0.00</td> </tr> <tr> <td>-3 .....</td><td>396.00</td> <td>-66 .....</td><td>153.00</td> <td>-Y .....</td><td>0.00</td> </tr> <tr> <td>-3C .....</td><td>329.00</td> <td>-IRMA• .....</td><td>460.00</td> <td>-Z .....</td><td>0.00</td> </tr> <tr> <td>-12** .....</td><td>103.00</td> <td>-TSO ◊ .....</td><td>184.00</td> <td></td><td></td> </tr> <tr> <td>-12-20** .....</td><td>160.00</td> <td>-T .....</td><td>77.00</td> <td></td><td></td> </tr> </table> <p>• Price up to 4". Each additional inch, add \$75.00. ◊ Cannot be used with Drain Receiver * Minimum Deck Opening 10.25" Dia. ** Specify Height, Price Per Inch</p>	LIST PRICE			PIPE SIZE	2", 3", 4"				\$2,066.00	-1 .....	\$147.00	-20 .....	\$283.00	-VP .....	\$143.00	-2 .....	249.00	-51 .....	Deduct 99.00	-X .....	0.00	-3 .....	396.00	-66 .....	153.00	-Y .....	0.00	-3C .....	329.00	-IRMA• .....	460.00	-Z .....	0.00	-12** .....	103.00	-TSO ◊ .....	184.00			-12-20** .....	160.00	-T .....	77.00			 <p><b>24060</b></p>	<p><b>15" SPECIAL-DUTY TOP COMPOSITION DECK FLANGE</b></p> <table border="1"> <thead> <tr> <th colspan="3">LIST PRICE</th> </tr> <tr> <th>PIPE SIZE</th> <th>4", 6"</th> <th>8"</th> </tr> </thead> <tbody> <tr> <td></td> <td>\$3,126.00</td> <td>\$3,505.00</td> </tr> </tbody> </table> <p><b>ADD FOR OPTIONS:</b></p> <table> <tr> <td>-1 .....</td><td>\$239.00</td> <td>-29-20 .....</td><td>\$508.00</td> <td>-51 .....</td><td>\$774.00</td> </tr> <tr> <td>-20 .....</td><td>1,087.00</td> <td>-31 .....</td><td>260.00</td> <td>-66 .....</td><td>153.00</td> </tr> <tr> <td>-29 .....</td><td>308.00</td> <td>-50 .....</td><td>895.00</td> <td>-VP .....</td><td>146.00</td> </tr> <tr> <td></td><td></td><td></td><td></td> <td>-X .....</td><td>0.00</td> </tr> </table> <p>* Specify Height, Price Per Inch</p>	LIST PRICE			PIPE SIZE	4", 6"	8"		\$3,126.00	\$3,505.00	-1 .....	\$239.00	-29-20 .....	\$508.00	-51 .....	\$774.00	-20 .....	1,087.00	-31 .....	260.00	-66 .....	153.00	-29 .....	308.00	-50 .....	895.00	-VP .....	146.00					-X .....	0.00						
LIST PRICE																																																																																							
PIPE SIZE	2", 3", 4"																																																																																						
		\$2,066.00																																																																																					
-1 .....	\$147.00	-20 .....	\$283.00	-VP .....	\$143.00																																																																																		
-2 .....	249.00	-51 .....	Deduct 99.00	-X .....	0.00																																																																																		
-3 .....	396.00	-66 .....	153.00	-Y .....	0.00																																																																																		
-3C .....	329.00	-IRMA• .....	460.00	-Z .....	0.00																																																																																		
-12** .....	103.00	-TSO ◊ .....	184.00																																																																																				
-12-20** .....	160.00	-T .....	77.00																																																																																				
LIST PRICE																																																																																							
PIPE SIZE	4", 6"	8"																																																																																					
	\$3,126.00	\$3,505.00																																																																																					
-1 .....	\$239.00	-29-20 .....	\$508.00	-51 .....	\$774.00																																																																																		
-20 .....	1,087.00	-31 .....	260.00	-66 .....	153.00																																																																																		
-29 .....	308.00	-50 .....	895.00	-VP .....	146.00																																																																																		
				-X .....	0.00																																																																																		
 <p><b>24020</b></p>	<p><b>9" SUPER-FLO® TOP, MEDIUM SUMP COMPOSITION DECK FLANGE</b></p> <table border="1"> <thead> <tr> <th colspan="3">LIST PRICE</th> </tr> <tr> <th>PIPE SIZE</th> <th>2", 3", 4"</th> <th></th> </tr> </thead> <tbody> <tr> <td></td> <td></td> <td>\$800.00</td> </tr> </tbody> </table> <p><b>ADD FOR OPTIONS:</b></p> <table> <tr> <td>-1 .....</td><td>\$147.00</td> <td>-31 .....</td><td>\$112.00</td> <td>-51 .....</td><td>\$319.00</td> </tr> <tr> <td>-20 .....</td><td>675.00</td> <td>-36 .....</td><td>209.00</td> <td>-66 .....</td><td>153.00</td> </tr> <tr> <td>-29 .....</td><td>65.00</td> <td>-38 .....</td><td>Deduct 88.00</td> <td>-HP .....</td><td>106.00</td> </tr> <tr> <td>-29-20 .....</td><td>143.00</td> <td>-50 .....</td><td>325.00</td> <td>-VP .....</td><td>146.00</td> </tr> <tr> <td></td><td></td><td></td><td></td> <td>-X .....</td><td>0.00</td> </tr> </table>	LIST PRICE			PIPE SIZE	2", 3", 4"				\$800.00	-1 .....	\$147.00	-31 .....	\$112.00	-51 .....	\$319.00	-20 .....	675.00	-36 .....	209.00	-66 .....	153.00	-29 .....	65.00	-38 .....	Deduct 88.00	-HP .....	106.00	-29-20 .....	143.00	-50 .....	325.00	-VP .....	146.00					-X .....	0.00	 <p><b>24200</b></p>	<p><b>16" PROMENADE TOP, ALL LEVEL BONDING FLANGE</b></p> <table border="1"> <thead> <tr> <th colspan="3">LIST PRICE</th> </tr> <tr> <th>PIPE SIZE</th> <th>2" - 6"</th> <th></th> </tr> </thead> <tbody> <tr> <td></td> <td></td> <td>\$4,776.00</td> </tr> </tbody> </table> <p><b>ADD FOR OPTIONS:</b></p> <table> <tr> <td>-1 .....</td><td>\$239.00</td> <td>-60 .....</td><td>\$219.00</td> <td>-VP .....</td><td>\$146.00</td> </tr> <tr> <td>-20 .....</td><td>950.00</td> <td>-60-50 .....</td><td>2,705.00</td> <td>-X .....</td><td>0.00</td> </tr> <tr> <td>-50 .....</td><td>2,011.00</td> <td>-60-51 .....</td><td>2,434.00</td> <td></td><td></td> </tr> <tr> <td>-51 .....</td><td>1,817.00</td> <td>-66 .....</td><td>153.00</td> <td></td><td></td> </tr> </table>	LIST PRICE			PIPE SIZE	2" - 6"				\$4,776.00	-1 .....	\$239.00	-60 .....	\$219.00	-VP .....	\$146.00	-20 .....	950.00	-60-50 .....	2,705.00	-X .....	0.00	-50 .....	2,011.00	-60-51 .....	2,434.00			-51 .....	1,817.00	-66 .....	153.00														
LIST PRICE																																																																																							
PIPE SIZE	2", 3", 4"																																																																																						
		\$800.00																																																																																					
-1 .....	\$147.00	-31 .....	\$112.00	-51 .....	\$319.00																																																																																		
-20 .....	675.00	-36 .....	209.00	-66 .....	153.00																																																																																		
-29 .....	65.00	-38 .....	Deduct 88.00	-HP .....	106.00																																																																																		
-29-20 .....	143.00	-50 .....	325.00	-VP .....	146.00																																																																																		
				-X .....	0.00																																																																																		
LIST PRICE																																																																																							
PIPE SIZE	2" - 6"																																																																																						
		\$4,776.00																																																																																					
-1 .....	\$239.00	-60 .....	\$219.00	-VP .....	\$146.00																																																																																		
-20 .....	950.00	-60-50 .....	2,705.00	-X .....	0.00																																																																																		
-50 .....	2,011.00	-60-51 .....	2,434.00																																																																																				
-51 .....	1,817.00	-66 .....	153.00																																																																																				
 <p><b>24500</b></p>	<p><b>9" SUPER-FLO® TOP, MEDIUM SUMP COMPOSITION DECK FLANGE</b></p> <table border="1"> <thead> <tr> <th colspan="4">LIST PRICE</th> </tr> <tr> <th>PIPE SIZE</th> <th>24500</th> <th>24500-45</th> <th>24500-90</th> </tr> </thead> <tbody> <tr> <td>2", 3"</td> <td>\$414.00</td> <td>\$526.00</td> <td>\$526.00</td> </tr> <tr> <td>4"</td> <td>601.00</td> <td>713.00</td> <td>713.00</td> </tr> </tbody> </table> <p><b>ADD FOR OPTIONS:</b></p> <table> <tr> <td>-20 .....</td><td>\$160.00</td> <td>-35 .....</td><td>\$0.00</td> <td>-90 .....</td><td>\$112.00</td> </tr> <tr> <td>-24 .....</td><td>87.00</td> <td>-45 .....</td><td>112.00</td> <td>-T .....</td><td>0.00</td> </tr> <tr> <td>-27 .....</td><td>79.00</td> <td>-50 .....</td><td>204.00</td> <td>-VP .....</td><td>53.00</td> </tr> <tr> <td>-33 .....</td><td>232.00</td> <td>-51 .....</td><td>119.00</td> <td></td><td></td> </tr> </table>	LIST PRICE				PIPE SIZE	24500	24500-45	24500-90	2", 3"	\$414.00	\$526.00	\$526.00	4"	601.00	713.00	713.00	-20 .....	\$160.00	-35 .....	\$0.00	-90 .....	\$112.00	-24 .....	87.00	-45 .....	112.00	-T .....	0.00	-27 .....	79.00	-50 .....	204.00	-VP .....	53.00	-33 .....	232.00	-51 .....	119.00			 <p><b>24500</b></p>	<p><b>SILL TYPE 4" DOME, SHALLOW SUMP</b></p> <table border="1"> <thead> <tr> <th colspan="4">LIST PRICE</th> </tr> <tr> <th>PIPE SIZE</th> <th>24500</th> <th>24500-45</th> <th>24500-90</th> </tr> </thead> <tbody> <tr> <td>2", 3"</td> <td>\$414.00</td> <td>\$526.00</td> <td>\$526.00</td> </tr> <tr> <td>4"</td> <td>601.00</td> <td>713.00</td> <td>713.00</td> </tr> </tbody> </table> <p><b>ADD FOR OPTIONS:</b></p> <table> <tr> <td>-20 .....</td><td>\$160.00</td> <td>-35 .....</td><td>\$0.00</td> <td>-90 .....</td><td>\$112.00</td> </tr> <tr> <td>-24 .....</td><td>87.00</td> <td>-45 .....</td><td>112.00</td> <td>-T .....</td><td>0.00</td> </tr> <tr> <td>-27 .....</td><td>79.00</td> <td>-50 .....</td><td>204.00</td> <td>-VP .....</td><td>53.00</td> </tr> <tr> <td>-33 .....</td><td>232.00</td> <td>-51 .....</td><td>119.00</td> <td></td><td></td> </tr> </table>	LIST PRICE				PIPE SIZE	24500	24500-45	24500-90	2", 3"	\$414.00	\$526.00	\$526.00	4"	601.00	713.00	713.00	-20 .....	\$160.00	-35 .....	\$0.00	-90 .....	\$112.00	-24 .....	87.00	-45 .....	112.00	-T .....	0.00	-27 .....	79.00	-50 .....	204.00	-VP .....	53.00	-33 .....	232.00	-51 .....	119.00						
LIST PRICE																																																																																							
PIPE SIZE	24500	24500-45	24500-90																																																																																				
2", 3"	\$414.00	\$526.00	\$526.00																																																																																				
4"	601.00	713.00	713.00																																																																																				
-20 .....	\$160.00	-35 .....	\$0.00	-90 .....	\$112.00																																																																																		
-24 .....	87.00	-45 .....	112.00	-T .....	0.00																																																																																		
-27 .....	79.00	-50 .....	204.00	-VP .....	53.00																																																																																		
-33 .....	232.00	-51 .....	119.00																																																																																				
LIST PRICE																																																																																							
PIPE SIZE	24500	24500-45	24500-90																																																																																				
2", 3"	\$414.00	\$526.00	\$526.00																																																																																				
4"	601.00	713.00	713.00																																																																																				
-20 .....	\$160.00	-35 .....	\$0.00	-90 .....	\$112.00																																																																																		
-24 .....	87.00	-45 .....	112.00	-T .....	0.00																																																																																		
-27 .....	79.00	-50 .....	204.00	-VP .....	53.00																																																																																		
-33 .....	232.00	-51 .....	119.00																																																																																				

 <p><b>24700</b></p>	<p><b>PARAPET TYPE, SLOPING GRATE</b></p> <table border="1"> <thead> <tr> <th colspan="3">LIST PRICE</th> </tr> <tr> <th>PIPE SIZE</th> <th>2", 3", 4"</th> <th>5", 6"</th> </tr> </thead> <tbody> <tr> <td></td> <td>\$1,038.00</td> <td>\$1,885.00</td> </tr> </tbody> </table> <p><b>ADD FOR OPTIONS:</b></p> <table> <tr> <td>-20 (2" - 4").....</td> <td>\$235.00</td> <td>-51 .....</td> <td>\$323.00</td> </tr> <tr> <td>-20 (5" - 6").....</td> <td>474.00</td> <td>-61 (2" - 4").....</td> <td>334.00</td> </tr> <tr> <td>-22 .....</td> <td>Deduct 422.00</td> <td>-61 (5" - 6").....</td> <td>560.00</td> </tr> <tr> <td>-24 .....</td> <td>441.00</td> <td>-61-20 (2" - 4") .....</td> <td>480.00</td> </tr> <tr> <td>-45 .....</td> <td>0.00</td> <td>-61-20 (5" - 6") .....</td> <td>623.00</td> </tr> <tr> <td>-50 .....</td> <td>580.00</td> <td></td> <td></td> </tr> </table>	LIST PRICE			PIPE SIZE	2", 3", 4"	5", 6"		\$1,038.00	\$1,885.00	-20 (2" - 4").....	\$235.00	-51 .....	\$323.00	-20 (5" - 6").....	474.00	-61 (2" - 4").....	334.00	-22 .....	Deduct 422.00	-61 (5" - 6").....	560.00	-24 .....	441.00	-61-20 (2" - 4") .....	480.00	-45 .....	0.00	-61-20 (5" - 6") .....	623.00	-50 .....	580.00			 <p><b>25030</b></p>	<p><b>DOWNSPOUT BOOT, GALVANIZED</b></p> <table border="1"> <thead> <tr> <th colspan="3">LIST PRICE</th> </tr> <tr> <th></th> <th></th> <th></th> </tr> </thead> <tbody> <tr> <td>4x3</td> <td>25033</td> <td>\$1,473.00</td> </tr> <tr> <td>5x4</td> <td>25034</td> <td>1,629.00</td> </tr> <tr> <td>5x3</td> <td>25035</td> <td>1,784.00</td> </tr> </tbody> </table>	LIST PRICE						4x3	25033	\$1,473.00	5x4	25034	1,629.00	5x3	25035	1,784.00																									
LIST PRICE																																																																												
PIPE SIZE	2", 3", 4"	5", 6"																																																																										
	\$1,038.00	\$1,885.00																																																																										
-20 (2" - 4").....	\$235.00	-51 .....	\$323.00																																																																									
-20 (5" - 6").....	474.00	-61 (2" - 4").....	334.00																																																																									
-22 .....	Deduct 422.00	-61 (5" - 6").....	560.00																																																																									
-24 .....	441.00	-61-20 (2" - 4") .....	480.00																																																																									
-45 .....	0.00	-61-20 (5" - 6") .....	623.00																																																																									
-50 .....	580.00																																																																											
LIST PRICE																																																																												
4x3	25033	\$1,473.00																																																																										
5x4	25034	1,629.00																																																																										
5x3	25035	1,784.00																																																																										
 <p><b>24720</b></p>	<p><b>PARAPET TYPE, ANGLE GRATE</b></p> <table border="1"> <thead> <tr> <th colspan="3">LIST PRICE</th> </tr> <tr> <th>PIPE SIZE</th> <th>24720</th> <th>24720-45</th> </tr> </thead> <tbody> <tr> <td>2", 3", 4"</td> <td>\$656.00</td> <td>\$656.00</td> </tr> <tr> <td>5", 6"</td> <td>1,246.00</td> <td>1,246.00</td> </tr> </tbody> </table> <p><b>ADD FOR OPTIONS:</b></p> <table> <tr> <td>-20 (2" - 4").....</td> <td>\$237.00</td> <td>-50 .....</td> <td>\$1,003.00</td> </tr> <tr> <td>-20 (5" - 6").....</td> <td>474.00</td> <td>-51 .....</td> <td>747.00</td> </tr> <tr> <td>-23 (2" - 4").....</td> <td>424.00</td> <td>-61 (2" - 4").....</td> <td>334.00</td> </tr> <tr> <td>-23 (5" - 6").....</td> <td>692.00</td> <td>-61 (5" - 6").....</td> <td>560.00</td> </tr> <tr> <td>-24 (2" - 4").....</td> <td>884.00</td> <td>-61-20 (2" - 4") .....</td> <td>480.00</td> </tr> <tr> <td>-24 (5" - 6").....</td> <td>1,445.00</td> <td>-61-20 (5" - 6") .....</td> <td>623.00</td> </tr> <tr> <td>-45 .....</td> <td>0.00</td> <td>-VP .....</td> <td>61.00</td> </tr> </table>	LIST PRICE			PIPE SIZE	24720	24720-45	2", 3", 4"	\$656.00	\$656.00	5", 6"	1,246.00	1,246.00	-20 (2" - 4").....	\$237.00	-50 .....	\$1,003.00	-20 (5" - 6").....	474.00	-51 .....	747.00	-23 (2" - 4").....	424.00	-61 (2" - 4").....	334.00	-23 (5" - 6").....	692.00	-61 (5" - 6").....	560.00	-24 (2" - 4").....	884.00	-61-20 (2" - 4") .....	480.00	-24 (5" - 6").....	1,445.00	-61-20 (5" - 6") .....	623.00	-45 .....	0.00	-VP .....	61.00	 <p><b>25500</b></p>	<p><b>FLO-SEPTOR®, LARGE SUMP</b></p> <table border="1"> <thead> <tr> <th colspan="3">LIST PRICE</th> </tr> <tr> <th>PIPE SIZE</th> <th>2", 3", 4"</th> <th>5", 6"</th> </tr> </thead> <tbody> <tr> <td></td> <td>\$928.00</td> <td>\$1,243.00</td> </tr> </tbody> </table> <p><b>ADD FOR OPTIONS:</b></p> <table> <tr> <td>-AE .....</td> <td>\$702.00</td> <td>-2 .....</td> <td>\$270.00</td> <td>-T .....</td> <td>\$77.00</td> </tr> <tr> <td>-CR .....</td> <td>414.00</td> <td>-3 .....</td> <td>509.00</td> <td>-X .....</td> <td>0.00</td> </tr> <tr> <td>-OR .....</td> <td>702.00</td> <td>-20 .....</td> <td>880.00</td> <td>-Y .....</td> <td>0.00</td> </tr> <tr> <td>-1 .....</td> <td>240.00</td> <td>-66 .....</td> <td>367.00</td> <td>-Z .....</td> <td>0.00</td> </tr> </table>	LIST PRICE			PIPE SIZE	2", 3", 4"	5", 6"		\$928.00	\$1,243.00	-AE .....	\$702.00	-2 .....	\$270.00	-T .....	\$77.00	-CR .....	414.00	-3 .....	509.00	-X .....	0.00	-OR .....	702.00	-20 .....	880.00	-Y .....	0.00	-1 .....	240.00	-66 .....	367.00	-Z .....	0.00
LIST PRICE																																																																												
PIPE SIZE	24720	24720-45																																																																										
2", 3", 4"	\$656.00	\$656.00																																																																										
5", 6"	1,246.00	1,246.00																																																																										
-20 (2" - 4").....	\$237.00	-50 .....	\$1,003.00																																																																									
-20 (5" - 6").....	474.00	-51 .....	747.00																																																																									
-23 (2" - 4").....	424.00	-61 (2" - 4").....	334.00																																																																									
-23 (5" - 6").....	692.00	-61 (5" - 6").....	560.00																																																																									
-24 (2" - 4").....	884.00	-61-20 (2" - 4") .....	480.00																																																																									
-24 (5" - 6").....	1,445.00	-61-20 (5" - 6") .....	623.00																																																																									
-45 .....	0.00	-VP .....	61.00																																																																									
LIST PRICE																																																																												
PIPE SIZE	2", 3", 4"	5", 6"																																																																										
	\$928.00	\$1,243.00																																																																										
-AE .....	\$702.00	-2 .....	\$270.00	-T .....	\$77.00																																																																							
-CR .....	414.00	-3 .....	509.00	-X .....	0.00																																																																							
-OR .....	702.00	-20 .....	880.00	-Y .....	0.00																																																																							
-1 .....	240.00	-66 .....	367.00	-Z .....	0.00																																																																							
 <p><b>24900</b></p>	<p><b>PARAPET TYPE, ANGLE DOME GRATE</b></p> <table border="1"> <thead> <tr> <th colspan="3">LIST PRICE</th> </tr> <tr> <th>PIPE SIZE</th> <th>2" - 6"</th> <th></th> </tr> </thead> <tbody> <tr> <td></td> <td></td> <td>\$3,721.00</td> </tr> </tbody> </table> <p><b>ADD FOR OPTIONS:</b></p> <table> <tr> <td>-20 .....</td> <td>\$528.00</td> <td>-61 (5" - 6").....</td> <td>\$560.00</td> </tr> <tr> <td>-24 .....</td> <td>580.00</td> <td>-61-20 (2" - 4") .....</td> <td>480.00</td> </tr> <tr> <td>-50 .....</td> <td>755.00</td> <td>-61-20 (5" - 6") .....</td> <td>623.00</td> </tr> <tr> <td>-51 .....</td> <td>535.00</td> <td>-VP .....</td> <td>61.00</td> </tr> <tr> <td>-61 (2" - 4").....</td> <td>334.00</td> <td></td> <td></td> </tr> </table>	LIST PRICE			PIPE SIZE	2" - 6"				\$3,721.00	-20 .....	\$528.00	-61 (5" - 6").....	\$560.00	-24 .....	580.00	-61-20 (2" - 4") .....	480.00	-50 .....	755.00	-61-20 (5" - 6") .....	623.00	-51 .....	535.00	-VP .....	61.00	-61 (2" - 4").....	334.00			<p><b>OPTION DESCRIPTIONS</b></p> <ul style="list-style-type: none"> <li>-AE LEVELEZE® Adjustable Extension</li> <li>-BS Bird Screen</li> <li>-CR Clamping Drain Receiver</li> <li>-HP Heel-Proof Grate</li> <li>-IRMA Perforated Stainless Steel Extension</li> <li>-OR Adjustable Extension with O-Ring</li> <li>-VP Vandal-Proof Dome</li> <li>-1 Deck Clamp Assembly</li> <li>-2 Drain Receiver</li> <li>-3 Deck Clamp Assembly and Drain Receiver</li> <li>-3C Drain Receiver and Drain Receiver Clips</li> <li>-10 Fixed Extension Collar, Cast Iron</li> <li>-10-20 Fixed Extension Collar, Galvanized</li> <li>-12 Extended Flashing Collar, Cast Iron</li> <li>-12-20 Extended Flashing Collar, Galvanized</li> <li>-20 Galvanized Cast Iron Parts</li> <li>-22 Cast Iron Grate</li> <li>-23 Rough Bronze Grate</li> <li>-24 Rough Nikaloy Dome or Grate</li> <li>-27 High Dome</li> <li>-29 Sediment Bucket, Cast Iron</li> <li>-29-20 Sediment Bucket, Galvanized</li> <li>-31 Chain Anchored Grate</li> <li>-33 Stainless Mesh Screen-Covered Dome</li> <li>-35 Flat Grate</li> <li>-36 Ductile Iron Grate (Cast Iron Top Only)</li> <li>-38 Less Grate</li> <li>-50 C.I. Undergrate Laminated Top, Satin Finish Nikaloy</li> <li>-51 C.I. Undergrate Laminated Top, Satin Finish Bronze</li> <li>-60 Square Top, Cast Iron</li> <li>-60-50 Square Top, Satin Finish Nikaloy</li> <li>-60-51 Square Top, Satin Finish Bronze</li> <li>-61 Downspout Elbow, Cast Iron</li> <li>-61-20 Downspout Elbow, Galvanized</li> <li>-316 Type 316L Stainless Steel</li> </ul> <p><b>Outlets</b></p> <ul style="list-style-type: none"> <li>-45 Body with 45 Degree Threaded Outlet</li> <li>-66 No-Hub Side Outlet, 2" - 6"</li> <li>-90 Body with 90 Degree Threaded Outlet</li> <li>-PVC Metal Nozzle to fit PVC Pipe</li> <li>-T Threaded Outlet</li> <li>-TSO Threaded Side Outlet</li> <li>-X Inside Caulk Outlet</li> <li>-Y Hub Outlet with Gasket, 2" - 4"</li> <li>-Z No-Hub Spigot Outlet</li> </ul>																																													
LIST PRICE																																																																												
PIPE SIZE	2" - 6"																																																																											
		\$3,721.00																																																																										
-20 .....	\$528.00	-61 (5" - 6").....	\$560.00																																																																									
-24 .....	580.00	-61-20 (2" - 4") .....	480.00																																																																									
-50 .....	755.00	-61-20 (5" - 6") .....	623.00																																																																									
-51 .....	535.00	-VP .....	61.00																																																																									
-61 (2" - 4").....	334.00																																																																											
 <p><b>25000</b></p>	<p><b>PARAPET SCUPPER SLEEVE</b></p> <table border="1"> <thead> <tr> <th colspan="5">LIST PRICE</th> </tr> <tr> <th>Wall Thickness</th> <th>9"</th> <th>13"</th> <th>17"</th> <th>21"</th> </tr> </thead> <tbody> <tr> <td></td> <td>\$928.00</td> <td>\$1,054.00</td> <td>\$1,302.00</td> <td>\$1,390.00</td> </tr> </tbody> </table> <p><b>ADD FOR OPTIONS:</b></p> <table> <tr> <td>-20 .....</td> <td>\$235.00</td> </tr> </table>	LIST PRICE					Wall Thickness	9"	13"	17"	21"		\$928.00	\$1,054.00	\$1,302.00	\$1,390.00	-20 .....	\$235.00																																																										
LIST PRICE																																																																												
Wall Thickness	9"	13"	17"	21"																																																																								
	\$928.00	\$1,054.00	\$1,302.00	\$1,390.00																																																																								
-20 .....	\$235.00																																																																											
 <p><b>25010</b></p>	<p><b>DOWNSPOUT NOZZLE</b></p> <table border="1"> <thead> <tr> <th colspan="6">LIST PRICE</th> </tr> <tr> <th>PIPE SIZE</th> <th>2", 3", 4"</th> <th>5", 6"</th> <th>8"</th> <th>10"</th> <th>*12"</th> </tr> </thead> <tbody> <tr> <td></td> <td>\$620.00</td> <td>\$1,474.00</td> <td>\$2,244.00</td> <td>\$2,912.00</td> <td>\$4,323.00</td> </tr> </tbody> </table> <p><b>ADD FOR OPTIONS:</b></p> <table> <tr> <td>-24 (2" - 6").....</td> <td>\$450.00</td> <td>-51 (10").....</td> <td>\$385.00</td> </tr> <tr> <td>-24 (8").....</td> <td>396.00</td> <td>-BS .....</td> <td>543.00</td> </tr> <tr> <td>-24 (10").....</td> <td>530.00</td> <td>-PVC.....</td> <td>0.00</td> </tr> <tr> <td>-51 (2" - 6").....</td> <td>283.00</td> <td>-T .....</td> <td>0.00</td> </tr> <tr> <td>-51 (8").....</td> <td>297.00</td> <td>-Z** .....</td> <td>0.00</td> </tr> </table> <p>* 12" Size No-Hub Only ** Bronze Only</p>	LIST PRICE						PIPE SIZE	2", 3", 4"	5", 6"	8"	10"	*12"		\$620.00	\$1,474.00	\$2,244.00	\$2,912.00	\$4,323.00	-24 (2" - 6").....	\$450.00	-51 (10").....	\$385.00	-24 (8").....	396.00	-BS .....	543.00	-24 (10").....	530.00	-PVC.....	0.00	-51 (2" - 6").....	283.00	-T .....	0.00	-51 (8").....	297.00	-Z** .....	0.00																																					
LIST PRICE																																																																												
PIPE SIZE	2", 3", 4"	5", 6"	8"	10"	*12"																																																																							
	\$620.00	\$1,474.00	\$2,244.00	\$2,912.00	\$4,323.00																																																																							
-24 (2" - 6").....	\$450.00	-51 (10").....	\$385.00																																																																									
-24 (8").....	396.00	-BS .....	543.00																																																																									
-24 (10").....	530.00	-PVC.....	0.00																																																																									
-51 (2" - 6").....	283.00	-T .....	0.00																																																																									
-51 (8").....	297.00	-Z** .....	0.00																																																																									
 <p><b>25020</b></p>	<p><b>SPECIAL PURPOSE DOWNSPOUT COVER</b></p> <table border="1"> <thead> <tr> <th colspan="4">LIST PRICE</th> </tr> <tr> <th>PIPE SIZE</th> <th>2", 3", 4"</th> <th>6"</th> <th>8"</th> </tr> </thead> <tbody> <tr> <td></td> <td>\$2,918.00</td> <td>\$3,109.00</td> <td>\$3,233.00</td> </tr> <tr> <th>PIPE SIZE</th> <th>10"</th> <th>12"</th> <th>15"</th> </tr> <tr> <td></td> <td>\$3,420.00</td> <td>\$3,629.00</td> <td>\$3,832.00</td> </tr> </tbody> </table> <p><b>ADD FOR OPTIONS:</b></p> <table> <tr> <td>-316 .....</td> <td>\$660.00</td> <td>-VP .....</td> <td>\$145.00</td> </tr> <tr> <td></td> <td></td> <td>-Z (4" - 15").....</td> <td>147.00</td> </tr> </table>	LIST PRICE				PIPE SIZE	2", 3", 4"	6"	8"		\$2,918.00	\$3,109.00	\$3,233.00	PIPE SIZE	10"	12"	15"		\$3,420.00	\$3,629.00	\$3,832.00	-316 .....	\$660.00	-VP .....	\$145.00			-Z (4" - 15").....	147.00																																															
LIST PRICE																																																																												
PIPE SIZE	2", 3", 4"	6"	8"																																																																									
	\$2,918.00	\$3,109.00	\$3,233.00																																																																									
PIPE SIZE	10"	12"	15"																																																																									
	\$3,420.00	\$3,629.00	\$3,832.00																																																																									
-316 .....	\$660.00	-VP .....	\$145.00																																																																									
		-Z (4" - 15").....	147.00																																																																									

	<b>FLO-SEPTOR®, MEDIUM SUMP</b>																																		
	<table border="1"> <thead> <tr> <th colspan="4">LIST PRICE</th> </tr> <tr> <th>PIPE SIZE</th> <th colspan="2">2" - 6"</th> <th>\$715.00</th> </tr> </thead> <tbody> <tr> <td colspan="4"><b>ADD FOR OPTIONS:</b></td> </tr> <tr> <td>-1 .....</td> <td>\$147.00</td> <td>-10* .....</td> <td>\$87.00</td> </tr> <tr> <td>-2 .....</td> <td>255.00</td> <td>-20 .....</td> <td>193.00</td> </tr> <tr> <td>-3 .....</td> <td>403.00</td> <td>-66 .....</td> <td>153.00</td> </tr> <tr> <td>-T .....</td> <td>\$77.00</td> <td>-X .....</td> <td>0.00</td> </tr> <tr> <td>-Z .....</td> <td>0.00</td> <td></td> <td></td> </tr> </tbody> </table> <p>* Price per inch</p>				LIST PRICE				PIPE SIZE	2" - 6"		\$715.00	<b>ADD FOR OPTIONS:</b>				-1 .....	\$147.00	-10* .....	\$87.00	-2 .....	255.00	-20 .....	193.00	-3 .....	403.00	-66 .....	153.00	-T .....	\$77.00	-X .....	0.00	-Z .....	0.00	
LIST PRICE																																			
PIPE SIZE	2" - 6"		\$715.00																																
<b>ADD FOR OPTIONS:</b>																																			
-1 .....	\$147.00	-10* .....	\$87.00																																
-2 .....	255.00	-20 .....	193.00																																
-3 .....	403.00	-66 .....	153.00																																
-T .....	\$77.00	-X .....	0.00																																
-Z .....	0.00																																		
	<b>FLO-SEPTOR®, SMALL SUMP</b>																																		
	<table border="1"> <thead> <tr> <th colspan="4">LIST PRICE</th> </tr> <tr> <th>PIPE SIZE</th> <th colspan="2">2", 3", 4"</th> <th>\$583.00</th> </tr> </thead> <tbody> <tr> <td colspan="4"><b>ADD FOR OPTIONS:</b></td> </tr> <tr> <td>-1 .....</td> <td>\$147.00</td> <td>-66 .....</td> <td>\$153.00</td> </tr> <tr> <td>-2 .....</td> <td>255.00</td> <td>-T .....</td> <td>77.00</td> </tr> <tr> <td>-3 .....</td> <td>403.00</td> <td>-TSO* .....</td> <td>216.00</td> </tr> <tr> <td>-20 .....</td> <td>193.00</td> <td>-X .....</td> <td>0.00</td> </tr> </tbody> </table> <p>* Cannot be used with Drain Receiver</p>				LIST PRICE				PIPE SIZE	2", 3", 4"		\$583.00	<b>ADD FOR OPTIONS:</b>				-1 .....	\$147.00	-66 .....	\$153.00	-2 .....	255.00	-T .....	77.00	-3 .....	403.00	-TSO* .....	216.00	-20 .....	193.00	-X .....	0.00			
LIST PRICE																																			
PIPE SIZE	2", 3", 4"		\$583.00																																
<b>ADD FOR OPTIONS:</b>																																			
-1 .....	\$147.00	-66 .....	\$153.00																																
-2 .....	255.00	-T .....	77.00																																
-3 .....	403.00	-TSO* .....	216.00																																
-20 .....	193.00	-X .....	0.00																																
	<b>EXPANSION JOINT</b>																																		
	<table border="1"> <thead> <tr> <th colspan="5">LIST PRICE</th> </tr> <tr> <th>PIPE SIZE</th> <th>2"</th> <th>3"</th> <th>4"</th> <th>5"</th> </tr> </thead> <tbody> <tr> <td></td> <td>\$656.00</td> <td>\$702.00</td> <td>\$791.00</td> <td>\$1,150.00</td> </tr> <tr> <th>PIPE SIZE</th> <th>6"</th> <th>8"</th> <th>10"</th> <td></td> </tr> <tr> <td></td> <td>\$1,319.00</td> <td>\$2,329.00</td> <td>\$4,846.00</td> <td></td> </tr> </tbody> </table> <p><b>ADD FOR OPTIONS:</b></p> <p>-BR.....\$286.00    -20.....\$176.00</p>				LIST PRICE					PIPE SIZE	2"	3"	4"	5"		\$656.00	\$702.00	\$791.00	\$1,150.00	PIPE SIZE	6"	8"	10"			\$1,319.00	\$2,329.00	\$4,846.00							
LIST PRICE																																			
PIPE SIZE	2"	3"	4"	5"																															
	\$656.00	\$702.00	\$791.00	\$1,150.00																															
PIPE SIZE	6"	8"	10"																																
	\$1,319.00	\$2,329.00	\$4,846.00																																
	<b>STACK FLASHING FITTING</b>																																		
	<table border="1"> <thead> <tr> <th colspan="4">LIST PRICE</th> </tr> <tr> <th>PIPE SIZE</th> <th>1 1/2"</th> <th>2"</th> <th>3"</th> </tr> </thead> <tbody> <tr> <td></td> <td>\$187.00</td> <td>\$187.00</td> <td>\$216.00</td> </tr> <tr> <th>PIPE SIZE</th> <th>4"</th> <th>5"</th> <th>6"</th> </tr> <tr> <td></td> <td>\$278.00</td> <td>\$403.00</td> <td>\$403.00</td> </tr> </tbody> </table> <p><b>ADD FOR OPTIONS:</b></p> <p>-20.....\$184.00</p>				LIST PRICE				PIPE SIZE	1 1/2"	2"	3"		\$187.00	\$187.00	\$216.00	PIPE SIZE	4"	5"	6"		\$278.00	\$403.00	\$403.00											
LIST PRICE																																			
PIPE SIZE	1 1/2"	2"	3"																																
	\$187.00	\$187.00	\$216.00																																
PIPE SIZE	4"	5"	6"																																
	\$278.00	\$403.00	\$403.00																																
	<b>VENT STACK FLASHING SLEEVE</b>																																		
	<table border="1"> <thead> <tr> <th colspan="4">LIST PRICE</th> </tr> <tr> <th>PIPE SIZE</th> <th>1 1/2"</th> <th>2"</th> <th>3"</th> </tr> </thead> <tbody> <tr> <td></td> <td>\$61.00</td> <td>\$61.00</td> <td>\$108.00</td> </tr> <tr> <th>PIPE SIZE</th> <th>4"</th> <th>5"</th> <th>6"</th> </tr> <tr> <td></td> <td>\$123.00</td> <td>\$160.00</td> <td>\$310.00</td> </tr> </tbody> </table> <p><b>ADD FOR OPTIONS:</b></p> <p>-20.....\$79.00</p>				LIST PRICE				PIPE SIZE	1 1/2"	2"	3"		\$61.00	\$61.00	\$108.00	PIPE SIZE	4"	5"	6"		\$123.00	\$160.00	\$310.00											
LIST PRICE																																			
PIPE SIZE	1 1/2"	2"	3"																																
	\$61.00	\$61.00	\$108.00																																
PIPE SIZE	4"	5"	6"																																
	\$123.00	\$160.00	\$310.00																																
	<b>VANDAL-PROOF VENT CAP</b>																																		
	<table border="1"> <thead> <tr> <th colspan="5">LIST PRICE</th> </tr> <tr> <th>PIPE SIZE</th> <th>1 1/2"</th> <th>2"</th> <th>2 1/2"</th> <th>3"</th> </tr> </thead> <tbody> <tr> <td></td> <td>\$414.00</td> <td>\$414.00</td> <td>\$464.00</td> <td>\$464.00</td> </tr> <tr> <th>PIPE SIZE</th> <th>4"</th> <th>5"</th> <th>6"</th> <td></td> </tr> <tr> <td></td> <td>\$520.00</td> <td>\$609.00</td> <td>\$667.00</td> <td></td> </tr> </tbody> </table> <p><b>ADD FOR OPTIONS:</b></p> <p>-20 .....</p> <p>-33 .....</p>				LIST PRICE					PIPE SIZE	1 1/2"	2"	2 1/2"	3"		\$414.00	\$414.00	\$464.00	\$464.00	PIPE SIZE	4"	5"	6"			\$520.00	\$609.00	\$667.00							
LIST PRICE																																			
PIPE SIZE	1 1/2"	2"	2 1/2"	3"																															
	\$414.00	\$414.00	\$464.00	\$464.00																															
PIPE SIZE	4"	5"	6"																																
	\$520.00	\$609.00	\$667.00																																
	<b>FLO-SET®, 15" DOME, LARGE SUMP</b>																																		
	<table border="1"> <thead> <tr> <th colspan="3">LIST PRICE</th> </tr> <tr> <th>PIPE SIZE</th> <th>28600</th> <th>28600-AE</th> </tr> </thead> <tbody> <tr> <td>2", 3", 4" 5", 6"</td> <td>\$1,862.00 \$2,163.00</td> <td>\$2,564.00 2,864.00</td> </tr> </tbody> </table> <p><b>ADD FOR OPTIONS:</b></p> <p>-1 .....</p> <p>-2 .....</p> <p>-3 .....</p> <p>-3C .....</p> <p>-4 .....</p> <p>-10** .....</p> <p>-10-20** .....</p> <p>-20 .....</p> <p>-23 .....</p> <p>-66 .....</p> <p>-AE .....</p> <p>-CR .....</p> <p>-T .....</p> <p>-VP .....</p> <p>-X .....</p> <p>-Y .....</p> <p>-Z .....</p> <p>* Minimum Deck Opening 16.5" Dia. ** Specify Height, Price Each 4" or Fraction</p>				LIST PRICE			PIPE SIZE	28600	28600-AE	2", 3", 4" 5", 6"	\$1,862.00 \$2,163.00	\$2,564.00 2,864.00																						
LIST PRICE																																			
PIPE SIZE	28600	28600-AE																																	
2", 3", 4" 5", 6"	\$1,862.00 \$2,163.00	\$2,564.00 2,864.00																																	
	<b>ISOLATION DECK DRAIN</b>																																		
	<table border="1"> <thead> <tr> <th colspan="4">LIST PRICE</th> </tr> <tr> <th>PIPE SIZE</th> <th>2", 3", 4"</th> <th>5", 6"</th> <th>8"</th> </tr> </thead> <tbody> <tr> <td></td> <td>\$702.00</td> <td>\$998.00</td> <td>\$1,302.00</td> </tr> </tbody> </table> <p><b>ADD FOR OPTIONS:</b></p> <p>-1 .....</p> <p>-2 .....</p> <p>-3 .....</p> <p>-3C .....</p> <p>-17 .....</p> <p>-20 .....</p> <p>-66 .....</p> <p>-CR .....</p> <p>-T .....</p> <p>-X .....</p> <p>-Y .....</p> <p>-Z .....</p> <p>* Minimum Deck Opening 16.5" Dia.</p>				LIST PRICE				PIPE SIZE	2", 3", 4"	5", 6"	8"		\$702.00	\$998.00	\$1,302.00																			
LIST PRICE																																			
PIPE SIZE	2", 3", 4"	5", 6"	8"																																
	\$702.00	\$998.00	\$1,302.00																																
	<b>16" DOME, EXTRA LARGE SUMP</b>																																		
	<table border="1"> <thead> <tr> <th colspan="4">LIST PRICE</th> </tr> <tr> <th>PIPE SIZE</th> <th>8"</th> <th>10"</th> <th>12"</th> </tr> </thead> <tbody> <tr> <td></td> <td>\$1,873.00</td> <td>\$2,060.00</td> <td>\$2,332.00</td> </tr> </tbody> </table> <p><b>ADD FOR OPTIONS:</b></p> <p>-1 .....</p> <p>-2 .....</p> <p>-3 .....</p> <p>-10* .....</p> <p>-10-20* .....</p> <p>-17 .....</p> <p>-20 .....</p> <p>-AER .....</p> <p>-VP .....</p> <p>-Z .....</p> <p>* Specify Height, Price Each 4" or Fraction</p>				LIST PRICE				PIPE SIZE	8"	10"	12"		\$1,873.00	\$2,060.00	\$2,332.00																			
LIST PRICE																																			
PIPE SIZE	8"	10"	12"																																
	\$1,873.00	\$2,060.00	\$2,332.00																																
<p><b>Roof Drain OPTION DESCRIPTIONS</b></p> <p>-AE LEVELEZE® Adjustable Extension</p> <p>-AER Adjustable Extension using Threaded Rod Hardware</p> <p>-BR Bronze Sleeve</p> <p>-CR Clamping Drain Receiver</p> <p>-VP Vandal-Proof Dome</p> <p>-1 Deck Clamp Assembly</p> <p>-2 Drain Receiver</p> <p>-3 Deck Clamp Assembly and Drain Receiver</p> <p>-3C Drain Receiver and Drain Receiver Clips</p> <p>-4 Secondary Flashing Clamp (use with -AE Only)</p> <p>-10 Fixed Extension Collar, Cast Iron</p> <p>-10-20 Fixed Extension Collar, Galvanized</p> <p>-17 2" High Solid Clamping Collar</p> <p>-20 Galvanized Cast Iron Parts</p> <p>-23 Rough Bronze Dome</p> <p>-33 Stainless Steel Mesh-Covered</p> <p>-63 All Rough Bronze</p> <p>-65 All Rough Nikaloy</p> <p><b>Outlets</b></p> <p>-66 No-Hub Side Outlet, 2" - 6"</p> <p>-T Threaded Outlet</p> <p>-TSO Threaded Side Outlet</p> <p>-X Inside Caulk Outlet</p> <p>-Y Hub Outlet with Gasket, 2" - 4"</p> <p>-Z No-Hub Spigot Outlet</p>																																			









	<b>ROUND NIKALOY SUPER-FLO® STRAINER</b>						<b>ROUND NIKALOY DOME STRAINER</b>						
	<b>LIST PRICE</b>						<b>LIST PRICE</b>						
	Strainer	Strainer Only	With 30000	With 30304	With 30000-ST		Strainer	Strainer Only	With 30000	With 30304	With 30000-ST		
	5A	\$286.00	\$473.00	\$371.00	\$919.00		5D	\$484.00	\$671.00	\$570.00	\$1,117.00		
	6A	395.00	582.00	482.00	1,027.00		6D	619.00	806.00	704.00	1,252.00		
	7A	484.00	671.00	569.00	1,117.00	<b>ADD FOR OPTIONS:</b>							
	8A	656.00	843.00	743.00	1,288.00	-2 (5D).....	Deduct \$37.00	-J .....	\$375.00				
	9A*	964.00	1,151.00	1,051.00	1,596.00	-2 (6D).....	Deduct 77.00	-TGI .....	POA				
	10A*	964.00	1,151.00	1,051.00	1,596.00	-80.....	108.00	-VP .....	53.00				
	<b>ADD FOR OPTIONS:</b>					<b>ADD FOR OPTIONS:</b>							
	-2 (5A).....		Deduct \$24.00	-DBC (8") .....		\$112.00							
	-2 (6A).....		Deduct 59.00	-HD (5", 6").....		204.00							
	-2 (7A).....		Deduct 35.00	-J .....		375.00							
	-2 (8A).....		Deduct 45.00	-SS (5A - 8A) .....		455.00							
	-2 (9A, 10A)* ..		Deduct 61.00	-SS-LR (6A) .....		1,315.00							
	-80.....		108.00	-SS-LR-MFP (6A)....		2,720.00							
	-5A-CP .....		44.00	-TGI .....		POA							
	-6A-CP .....		47.00	-VP .....		53.00							
	-DBC (5", 6") .....		62.00										
	* Not SUPER-FLO® Design												
	<b>ROUND NIKALOY STRAINER w/CLAMP DEVICE</b>						<b>ROUND NIKALOY TRACTOR STRAINER</b>						
	<b>LIST PRICE</b>						<b>LIST PRICE</b>						
	Strainer	Strainer Only	With 30000	With 30304	With 30000-ST		Strainer	Strainer Only	With 30000	With 30304	With 30000-ST		
	6AD	\$1,379.00	\$1,566.00	\$1,466.00	\$2,012.00		6E	\$727.00	\$914.00	\$814.00	\$1,360.00		
	<b>ADD FOR OPTIONS:</b>						7E	917.00	1,103.00	1,003.00	1,550.00		
	-2.....		Deduct \$157.00	-J .....		\$375.00	9E	1,344.00	1,531.00	1,430.00	1,977.00		
	-80.....		108.00	-TGI .....		POA	<b>ADD FOR OPTIONS:</b>						
				-VP .....		53.00	-2 (6E) .....	Deduct \$59.00	-J .....		\$375.00		
							-2 (7E) .....	Deduct 92.00	-SS (6E).....		455.00		
							-2 (9E) .....	Deduct 108.00	-SS (7E).....		455.00		
							-80.....	108.00	-TGI .....		POA		
							-93 (7E) .....	Deduct 567.00	-VP .....		53.00		
	<b>ADD FOR OPTIONS:</b>						<b>ADD FOR OPTIONS:</b>						
	-2.....		Deduct \$157.00	-J .....		\$375.00							
	-80.....		108.00	-TGI .....		POA							
				-VP .....		53.00							
	<b>ROUND NIKALOY STRAINER WITH TILE FLANGE</b>						<b>ROUND NIKALOY STRAINER w/EXTENDED RIM</b>						
	<b>LIST PRICE</b>						<b>LIST PRICE</b>						
	Strainer	Strainer Only	With 30000	With 30304	With 30000-ST		Strainer	Strainer Only	With 30000	With 30304	With 30000-ST		
	6AF	\$917.00	\$1,103.00	\$1,003.00	\$1,550.00		6E1	\$774.00	\$961.00	\$861.00	\$1,407.00		
	<b>ADD FOR OPTIONS:</b>						7E1	917.00	1,103.00	1,003.00	1,550.00		
	-2.....		Deduct \$92.00	-TGI .....		POA	9E1	1,359.00	1,546.00	1,445.00	1,991.00		
	-80.....		108.00	-VP .....		53.00	<b>ADD FOR OPTIONS:</b>						
	-J .....		375.00						-2 (6E1) .....	Deduct \$106.00	-J .....		\$375.00
									-2 (7E1) .....	Deduct 95.00	-TGI .....		POA
									-2 (9E1) .....	Deduct 127.00	-VP .....		53.00
									-80.....	108.00			
	<b>ADD FOR OPTIONS:</b>						<b>ADD FOR OPTIONS:</b>						
	-2.....		Deduct \$92.00	-TGI .....		POA							
	-80.....		108.00	-VP .....		53.00							
	-J .....		375.00										
	<b>ROUND NIKALOY NON-CLOG STRAINER WITH INTEGRAL BUCKET</b>						<b>ROUND NIKALOY STRAINER w/ROUND FUNNEL</b>						
	<b>LIST PRICE</b>						<b>LIST PRICE</b>						
	Strainer	Strainer Only	With 30000	With 30304	With 30000-ST		Strainer	Strainer Only	With 30000	With 30304	With 30000-ST		
	5C	\$760.00	\$947.00	\$846.00	\$1,393.00		7E2	\$906.00	\$1,093.00	\$992.00	\$1,539.00		
	<b>ADD FOR OPTIONS:</b>						<b>ADD FOR OPTIONS:</b>						
	-2.....		Deduct \$44.00	-VP .....		\$53.00	<b>ADD FOR OPTIONS:</b>						
	-TGI .....		POA						-2.....	Deduct \$92.00	-TGI .....		POA
									-80.....	108.00	-VP .....		53.00
									-J .....	375.00			









### STRAINER - OPTION DESCRIPTIONS

-CP	Chrome Plated	-TGI	Trap Guard Insert
-DBC	Debris Cover	-VP	Secured Grate, Vandal-Proof Screws
-HD	Heavy-Duty Heel Proof (Nikaloy Only)	-2	Satin Finish Bronze
-J	Backwater Valve	-63	Spanner Wrench
-SS	Stainless Steel	-80	Perforated Stainless Steel Basket
-SS-LR	SS Ligature Resistant	-93	Cast Iron Strainer
-SS-LR-MFP	SS Ligature Resistant, Mirror Polish Finish		

# FLOOR DRAINS • Strainers





<div style="text-align: center;"><b>E3</b></div> 	<p><b>ROUND NIKALOY STRAINER w/OVAL FUNNEL</b></p> <p style="text-align: center;">LIST PRICE</p> <table border="1"> <thead> <tr> <th>Strainer</th> <th>Strainer Only</th> <th>With 30000</th> <th>With 30304</th> <th>With 30000-ST</th> </tr> </thead> <tbody> <tr> <td>7E3</td> <td>\$1,354.00</td> <td>\$1,541.00</td> <td>\$1,441.00</td> <td>\$1,987.00</td> </tr> </tbody> </table> <p><b>ADD FOR OPTIONS:</b></p> <table> <tr> <td>-2..... Deduct \$92.00</td> <td>-J ..... Deduct \$375.00</td> </tr> <tr> <td>-80..... Deduct 108.00</td> <td>-TGI ..... Deduct POA</td> </tr> <tr> <td></td> <td>-VP ..... Deduct 53.00</td> </tr> </table>	Strainer	Strainer Only	With 30000	With 30304	With 30000-ST	7E3	\$1,354.00	\$1,541.00	\$1,441.00	\$1,987.00	-2..... Deduct \$92.00	-J ..... Deduct \$375.00	-80..... Deduct 108.00	-TGI ..... Deduct POA		-VP ..... Deduct 53.00	<div style="text-align: center;"><b>G</b></div> 	<p><b>ROUND NIKALOY STRAINER WITH SOLID HINGED COVER</b></p> <p style="text-align: center;">LIST PRICE</p> <table border="1"> <thead> <tr> <th>Strainer</th> <th>Strainer Only</th> <th>With 30000</th> <th>With 30304</th> <th>With 30000-ST</th> </tr> </thead> <tbody> <tr> <td>5G</td> <td>\$671.00</td> <td>\$857.00</td> <td>\$755.00</td> <td>\$1,302.00</td> </tr> <tr> <td>6G</td> <td>763.00</td> <td>950.00</td> <td>847.00</td> <td>1,395.00</td> </tr> <tr> <td>7G</td> <td>1,188.00</td> <td>1,375.00</td> <td>1,275.00</td> <td>1,821.00</td> </tr> <tr> <td>8G</td> <td>1,208.00</td> <td>1,395.00</td> <td>1,295.00</td> <td>1,840.00</td> </tr> </tbody> </table> <p><b>ADD FOR OPTIONS:</b></p> <table> <tr> <td>-2 (5G)..... Deduct \$53.00</td> <td>-J ..... Deduct \$375.00</td> </tr> <tr> <td>-2 (6G)..... Deduct 106.00</td> <td>-TGI ..... Deduct POA</td> </tr> <tr> <td>-2 (7G)..... Deduct 144.00</td> <td>-VP ..... Deduct 53.00</td> </tr> <tr> <td>-2 (8G)..... Deduct 108.00</td> <td></td> </tr> </table>	Strainer	Strainer Only	With 30000	With 30304	With 30000-ST	5G	\$671.00	\$857.00	\$755.00	\$1,302.00	6G	763.00	950.00	847.00	1,395.00	7G	1,188.00	1,375.00	1,275.00	1,821.00	8G	1,208.00	1,395.00	1,295.00	1,840.00	-2 (5G)..... Deduct \$53.00	-J ..... Deduct \$375.00	-2 (6G)..... Deduct 106.00	-TGI ..... Deduct POA	-2 (7G)..... Deduct 144.00	-VP ..... Deduct 53.00	-2 (8G)..... Deduct 108.00	
Strainer	Strainer Only	With 30000	With 30304	With 30000-ST																																																
7E3	\$1,354.00	\$1,541.00	\$1,441.00	\$1,987.00																																																
-2..... Deduct \$92.00	-J ..... Deduct \$375.00																																																			
-80..... Deduct 108.00	-TGI ..... Deduct POA																																																			
	-VP ..... Deduct 53.00																																																			
Strainer	Strainer Only	With 30000	With 30304	With 30000-ST																																																
5G	\$671.00	\$857.00	\$755.00	\$1,302.00																																																
6G	763.00	950.00	847.00	1,395.00																																																
7G	1,188.00	1,375.00	1,275.00	1,821.00																																																
8G	1,208.00	1,395.00	1,295.00	1,840.00																																																
-2 (5G)..... Deduct \$53.00	-J ..... Deduct \$375.00																																																			
-2 (6G)..... Deduct 106.00	-TGI ..... Deduct POA																																																			
-2 (7G)..... Deduct 144.00	-VP ..... Deduct 53.00																																																			
-2 (8G)..... Deduct 108.00																																																				
<div style="text-align: center;"><b>F</b></div> 	<p><b>ROUND NIKALOY STRAINER WITH SOLID THREADED COVER</b></p> <p style="text-align: center;">LIST PRICE</p> <table border="1"> <thead> <tr> <th>Strainer</th> <th>Strainer Only</th> <th>With 30000</th> <th>With 30304</th> <th>With 30000-ST</th> </tr> </thead> <tbody> <tr> <td>6F</td> <td>\$931.00</td> <td>\$1,118.00</td> <td>\$1,016.00</td> <td>\$1,563.00</td> </tr> </tbody> </table> <p><b>ADD FOR OPTIONS:</b></p> <table> <tr> <td>-2..... Deduct \$73.00</td> <td>-80..... Deduct \$108.00</td> </tr> <tr> <td>-63..... Deduct 136.00</td> <td>-J ..... Deduct 375.00</td> </tr> <tr> <td></td> <td>-TGI ..... Deduct POA</td> </tr> </table>	Strainer	Strainer Only	With 30000	With 30304	With 30000-ST	6F	\$931.00	\$1,118.00	\$1,016.00	\$1,563.00	-2..... Deduct \$73.00	-80..... Deduct \$108.00	-63..... Deduct 136.00	-J ..... Deduct 375.00		-TGI ..... Deduct POA	<div style="text-align: center;"><b>H</b></div> 	<p><b>ROUND NIKALOY STRAINER WITH HINGED GRATE</b></p> <p style="text-align: center;">LIST PRICE</p> <table border="1"> <thead> <tr> <th>Strainer</th> <th>Strainer Only</th> <th>With 30000</th> <th>With 30304</th> <th>With 30000-ST</th> </tr> </thead> <tbody> <tr> <td>5H</td> <td>\$560.00</td> <td>\$747.00</td> <td>\$647.00</td> <td>\$1,193.00</td> </tr> <tr> <td>6H</td> <td>619.00</td> <td>806.00</td> <td>704.00</td> <td>1,252.00</td> </tr> <tr> <td>7H</td> <td>763.00</td> <td>950.00</td> <td>847.00</td> <td>1,395.00</td> </tr> <tr> <td>8H</td> <td>859.00</td> <td>1,046.00</td> <td>946.00</td> <td>1,492.00</td> </tr> </tbody> </table> <p><b>ADD FOR OPTIONS:</b></p> <table> <tr> <td>-2 (5H)..... Deduct \$40.00</td> <td>-80 (6H - 8H)..... \$108.00</td> </tr> <tr> <td>-2 (6H)..... Deduct 59.00</td> <td>-J ..... Deduct 375.00</td> </tr> <tr> <td>-2 (7H)..... Deduct 35.00</td> <td>-TGI ..... Deduct POA</td> </tr> <tr> <td>-2 (8H)..... Deduct 77.00</td> <td>-VP ..... Deduct 53.00</td> </tr> </table>	Strainer	Strainer Only	With 30000	With 30304	With 30000-ST	5H	\$560.00	\$747.00	\$647.00	\$1,193.00	6H	619.00	806.00	704.00	1,252.00	7H	763.00	950.00	847.00	1,395.00	8H	859.00	1,046.00	946.00	1,492.00	-2 (5H)..... Deduct \$40.00	-80 (6H - 8H)..... \$108.00	-2 (6H)..... Deduct 59.00	-J ..... Deduct 375.00	-2 (7H)..... Deduct 35.00	-TGI ..... Deduct POA	-2 (8H)..... Deduct 77.00	-VP ..... Deduct 53.00
Strainer	Strainer Only	With 30000	With 30304	With 30000-ST																																																
6F	\$931.00	\$1,118.00	\$1,016.00	\$1,563.00																																																
-2..... Deduct \$73.00	-80..... Deduct \$108.00																																																			
-63..... Deduct 136.00	-J ..... Deduct 375.00																																																			
	-TGI ..... Deduct POA																																																			
Strainer	Strainer Only	With 30000	With 30304	With 30000-ST																																																
5H	\$560.00	\$747.00	\$647.00	\$1,193.00																																																
6H	619.00	806.00	704.00	1,252.00																																																
7H	763.00	950.00	847.00	1,395.00																																																
8H	859.00	1,046.00	946.00	1,492.00																																																
-2 (5H)..... Deduct \$40.00	-80 (6H - 8H)..... \$108.00																																																			
-2 (6H)..... Deduct 59.00	-J ..... Deduct 375.00																																																			
-2 (7H)..... Deduct 35.00	-TGI ..... Deduct POA																																																			
-2 (8H)..... Deduct 77.00	-VP ..... Deduct 53.00																																																			
<div style="text-align: center;"><b>F4, F6</b></div> 	<p><b>ROUND NIKALOY FUNNEL ASSEMBLIES</b></p> <p style="text-align: center;">LIST PRICE</p> <table border="1"> <thead> <tr> <th>Funnel</th> <th>Price</th> </tr> </thead> <tbody> <tr> <td>F4</td> <td>\$420.00</td> </tr> <tr> <td>F6</td> <td>\$620.00</td> </tr> </tbody> </table> <p><b>ADD FOR OPTIONS:</b></p> <table> <tr> <td>-2..... Deduct \$61.00</td> <td>-93 (F4) ..... Deduct \$245.00</td> </tr> <tr> <td>-92 (F4) ..... Deduct 189.00</td> <td>-93 (F6) ..... Deduct 339.00</td> </tr> <tr> <td>-92 (F6) ..... Deduct 284.00</td> <td>-ARE ..... Deduct 204.00</td> </tr> </table>	Funnel	Price	F4	\$420.00	F6	\$620.00	-2..... Deduct \$61.00	-93 (F4) ..... Deduct \$245.00	-92 (F4) ..... Deduct 189.00	-93 (F6) ..... Deduct 339.00	-92 (F6) ..... Deduct 284.00	-ARE ..... Deduct 204.00	<div style="text-align: center;"><b>M</b></div> 	<p><b>ROUND CHROME PLATED OVERFLOW STANDPIPE WITH DOME</b></p> <p style="text-align: center;">LIST PRICE</p> <table border="1"> <thead> <tr> <th>Strainer</th> <th>Strainer Only</th> <th>With 30000</th> <th>With 30304</th> <th>With 30000-ST</th> </tr> </thead> <tbody> <tr> <td>2M</td> <td>\$1,749.00</td> <td>\$1,935.00</td> <td>\$1,835.00</td> <td>\$2,382.00</td> </tr> <tr> <td>3M</td> <td>2,233.00</td> <td>2,420.00</td> <td>2,318.00</td> <td>2,866.00</td> </tr> </tbody> </table> <p><b>ADD FOR OPTIONS:</b></p> <table> <tr> <td>-2 (2M)..... Deduct \$297.00</td> <td>-24 (3M)..... Deduct \$375.00</td> </tr> <tr> <td>-2 (3M)..... Deduct 185.00</td> <td>-PF ..... Deduct 343.00</td> </tr> <tr> <td>-24 (2M)..... Deduct 279.00</td> <td></td> </tr> <tr> <td>For Each Inch Over 6" Standard</td> <td>CP</td> <td>-2</td> </tr> <tr> <td>Add for 2M</td> <td>\$133.00</td> <td>\$97.00</td> </tr> <tr> <td>Add for 3M</td> <td>189.00</td> <td>167.00</td> </tr> </table>	Strainer	Strainer Only	With 30000	With 30304	With 30000-ST	2M	\$1,749.00	\$1,935.00	\$1,835.00	\$2,382.00	3M	2,233.00	2,420.00	2,318.00	2,866.00	-2 (2M)..... Deduct \$297.00	-24 (3M)..... Deduct \$375.00	-2 (3M)..... Deduct 185.00	-PF ..... Deduct 343.00	-24 (2M)..... Deduct 279.00		For Each Inch Over 6" Standard	CP	-2	Add for 2M	\$133.00	\$97.00	Add for 3M	189.00	167.00							
Funnel	Price																																																			
F4	\$420.00																																																			
F6	\$620.00																																																			
-2..... Deduct \$61.00	-93 (F4) ..... Deduct \$245.00																																																			
-92 (F4) ..... Deduct 189.00	-93 (F6) ..... Deduct 339.00																																																			
-92 (F6) ..... Deduct 284.00	-ARE ..... Deduct 204.00																																																			
Strainer	Strainer Only	With 30000	With 30304	With 30000-ST																																																
2M	\$1,749.00	\$1,935.00	\$1,835.00	\$2,382.00																																																
3M	2,233.00	2,420.00	2,318.00	2,866.00																																																
-2 (2M)..... Deduct \$297.00	-24 (3M)..... Deduct \$375.00																																																			
-2 (3M)..... Deduct 185.00	-PF ..... Deduct 343.00																																																			
-24 (2M)..... Deduct 279.00																																																				
For Each Inch Over 6" Standard	CP	-2																																																		
Add for 2M	\$133.00	\$97.00																																																		
Add for 3M	189.00	167.00																																																		
<div style="text-align: center;"><b>F8, F9</b></div> 	<p><b>OVAL NIKALOY FUNNEL ASSEMBLIES</b></p> <p style="text-align: center;">LIST PRICE</p> <table border="1"> <thead> <tr> <th>Funnel</th> <th>Price</th> </tr> </thead> <tbody> <tr> <td>F8</td> <td>\$420.00</td> </tr> <tr> <td>F9</td> <td>870.00</td> </tr> </tbody> </table> <p><b>ADD FOR OPTIONS:</b></p> <table> <tr> <td>-2..... Deduct \$61.00</td> <td>-93 (F8) ..... Deduct \$245.00</td> </tr> <tr> <td>-92 (F8) ..... Deduct 189.00</td> <td>-93 (F9) ..... Deduct 448.00</td> </tr> <tr> <td>-92 (F9) ..... Deduct 391.00</td> <td>-ARE ..... Deduct 204.00</td> </tr> </table>	Funnel	Price	F8	\$420.00	F9	870.00	-2..... Deduct \$61.00	-93 (F8) ..... Deduct \$245.00	-92 (F8) ..... Deduct 189.00	-93 (F9) ..... Deduct 448.00	-92 (F9) ..... Deduct 391.00	-ARE ..... Deduct 204.00																																							
Funnel	Price																																																			
F8	\$420.00																																																			
F9	870.00																																																			
-2..... Deduct \$61.00	-93 (F8) ..... Deduct \$245.00																																																			
-92 (F8) ..... Deduct 189.00	-93 (F9) ..... Deduct 448.00																																																			
-92 (F9) ..... Deduct 391.00	-ARE ..... Deduct 204.00																																																			
<div style="text-align: center;"><b>F52, F53</b></div> 	<p><b>ROUND CAST IRON FUNNEL ASSEMBLIES</b></p> <p style="text-align: center;">LIST PRICE</p> <table border="1"> <thead> <tr> <th>Funnel</th> <th>Price</th> </tr> </thead> <tbody> <tr> <td>F52</td> <td>\$323.00</td> </tr> <tr> <td>F53</td> <td>430.00</td> </tr> </tbody> </table> <p><b>ADD FOR OPTIONS:</b></p> <table> <tr> <td>-1..... \$532.00</td> <td>-92..... \$127.00</td> </tr> </table>	Funnel	Price	F52	\$323.00	F53	430.00	-1..... \$532.00	-92..... \$127.00	<div style="text-align: center;"><b>P</b></div> 	<p><b>ANGLE NIKALOY STRAINER</b></p> <p style="text-align: center;">LIST PRICE</p> <table border="1"> <thead> <tr> <th>Strainer</th> <th>Strainer Only</th> <th>With 30000</th> <th>With 30304</th> <th>With 30000-ST</th> </tr> </thead> <tbody> <tr> <td>4P</td> <td>\$1,749.00</td> <td>\$1,935.00</td> <td>\$1,835.00</td> <td>\$2,382.00</td> </tr> <tr> <td>6P</td> <td>2,233.00</td> <td>2,420.00</td> <td>2,318.00</td> <td>2,866.00</td> </tr> </tbody> </table> <p><b>ADD FOR OPTIONS:</b></p> <table> <tr> <td>-2 (4P) ..... Deduct \$147.00</td> <td>-80..... Deduct \$117.00</td> </tr> <tr> <td>-2 (6P) ..... Deduct 185.00</td> <td>-TGI ..... Deduct POA</td> </tr> <tr> <td></td> <td>-VP ..... Deduct 53.00</td> </tr> </table>	Strainer	Strainer Only	With 30000	With 30304	With 30000-ST	4P	\$1,749.00	\$1,935.00	\$1,835.00	\$2,382.00	6P	2,233.00	2,420.00	2,318.00	2,866.00	-2 (4P) ..... Deduct \$147.00	-80..... Deduct \$117.00	-2 (6P) ..... Deduct 185.00	-TGI ..... Deduct POA		-VP ..... Deduct 53.00																				
Funnel	Price																																																			
F52	\$323.00																																																			
F53	430.00																																																			
-1..... \$532.00	-92..... \$127.00																																																			
Strainer	Strainer Only	With 30000	With 30304	With 30000-ST																																																
4P	\$1,749.00	\$1,935.00	\$1,835.00	\$2,382.00																																																
6P	2,233.00	2,420.00	2,318.00	2,866.00																																																
-2 (4P) ..... Deduct \$147.00	-80..... Deduct \$117.00																																																			
-2 (6P) ..... Deduct 185.00	-TGI ..... Deduct POA																																																			
	-VP ..... Deduct 53.00																																																			

<b>R</b> 	<b>RECTANGULAR NIKALOY STRAINER</b>					<b>WF6A</b> <b>WF6S</b> 	<b>NIKALOY STRAINERS FOR COMPOSITION DECKS</b>				
	<b>LIST PRICE</b>						<b>LIST PRICE</b>				
	Strainer	Strainer Only	With 30000	With 30304	With 30000-ST	Strainer	Strainer Only	With 30000	With 30304	With 30000-ST	
	5R	\$859.00	\$1,046.00	\$946.00	\$1,492.00	6A	\$1,064.00	\$1,251.00	\$1,150.00	\$1,696.00	
	6R	1,232.00	1,419.00	1,319.00	1,865.00	6S	1,188.00	1,375.00	1,275.00	1,821.00	
	7R	1,320.00	1,507.00	1,406.00	1,953.00	<b>ADD FOR OPTIONS:</b>					
	8R	1,991.00	2,178.00	2,078.00	2,624.00	-2 (6A)..... Deduct \$59.00    -J ..... \$375.00 -2 (6S) ..... Deduct 35.00    -TGI ..... POA -80 ..... 108.00    -VP ..... 53.00 Can be used with all Floor Drain Bodies on this Page.					
<b>ADD FOR OPTIONS:</b>						<b>1/4" NIKALOY RIM AND GRATE EXTENSION</b>					
-2 (5R) ..... Deduct \$77.00    -80 ..... \$108.00 -2 (6R, 7R).... Deduct 133.00    -J ..... 375.00 -2 (8R) ..... Deduct 259.00    -TGI ..... POA -VP ..... 53.00						<b>LIST PRICE</b>					
<b>S</b> 	<b>SQUARE NIKALOY SUPER-FLO® STRAINER</b>					<b>NBRG</b> 	<b>LIST PRICE</b>				
	Strainer	Strainer Only	With 30000	With 30304	With 30000-ST		Type No.	NBRG	Type No.	NBR* (1/4" Rim Only)	
	5S	\$448.00	\$635.00	\$535.00	\$1,080.00	5A-NBRG	\$134.00	5A-NBR†	\$42.00		
	6S	520.00	707.00	607.00	1,153.00	6A-NBRG	152.00	6A-NBR	58.00		
	8S	839.00	1,026.00	926.00	1,472.00	<small>*Standard strainer grates will not fit NBR rims.                      †5A-NBR Can be used with Nikaloy Top 55000-1.                      (Can not be used with 4" X and 6" Z)</small>					
	9S	1,118.00	1,305.00	1,203.00	1,750.00	<b>DEBRIS COVER</b>					
<b>ADD FOR OPTIONS:</b>						<b>LIST PRICE</b>					
-2 (5S) ..... Deduct \$53.00    -DBC (5", 6") ..... \$62.00 -2 (6S) ..... Deduct 35.00    -DBC (8") ..... 112.00 -2 (8S) ..... Deduct 95.00    -HD (5", 6") ..... 204.00 -2 (9S) * ..... Deduct 108.00    -J ..... 375.00 -5S-CP ..... 53.00    -SS (5S - 8S) ..... 455.00 -6S-CP ..... 65.00    -TGI ..... POA -80 ..... 108.00    -VP ..... 53.00 * Not SUPER-FLO® design						Type No. 5A-DBC, 6A-DBC    \$62.00 5S-DBC, 6S-DBC    62.00 8A-DBC, 8S-DBC    112.00					
Square not depicted.						<b>BODIES ONLY</b>					
<b>T</b> 	<b>SQUARE NIKALOY STRAINER w/HINGED GRATE</b>					<b>30000</b> 	<b>BODY ASSEMBLY</b>				
	<b>LIST PRICE</b>						<b>LIST PRICE</b>				
	Strainer	Strainer Only	With 30000	With 30304	With 30000-ST	PIPE SIZE	30000	30000-TSO	30002-ST 30003-ST	30000-PD	
	5T	\$656.00	\$843.00	\$743.00	\$1,288.00	2" - 4"	\$187.00	\$403.00	\$633.00	\$702.00	
	6T	791.00	978.00	877.00	1,423.00	6" (Z)	639.00	—	—	—	
	9T	1,439.00	1,626.00	1,525.00	2,071.00	<b>ADD FOR OPTIONS:</b>					
<b>ADD FOR OPTIONS:</b>						-49 ..... \$0.00    -PD ..... \$515.00 -50 ..... STD    -ST ..... 446.00 -91 ..... 1,195.00    -T ..... 77.00 -92 ..... 193.00    -TGI† ..... POA -ARE ..... 172.00    -TSO ..... 216.00 -CC4 ..... 550.00    -X ..... 0.00 -MD ..... 108.00    -Y ..... 0.00 -PFB ..... 139.00    -Z (2" - 4") ..... 0.00 † Available up to 4" only					
<b>W</b> 	<b>CAST IRON STRAINER EXTENSION</b>					<b>30000-PD</b> 	<b>SECURITY BODY ASSEMBLY FOR PRISONS</b>				
	<b>LIST PRICE</b>						<b>LIST PRICE</b>				
	Strainer	Strainer Only	With 30000	With 30304	With 30000-ST	PIPE SIZE	30000-PD				
	2W	\$136.00	\$323.00	\$223.00	\$768.00	2", 3"	\$702.00				
	4W	245.00	432.00	332.00	878.00	<b>ADD FOR OPTIONS:</b>					
	6W	367.00	554.00	454.00	999.00	-50 ..... \$0.00    -C ..... \$0.00 -92 ..... 193.00    -T ..... 0.00					
<b>ADD FOR OPTIONS:</b>						<b>BODY ASSEMBLY WITH THREADED SIDE OUTLET</b>					
-TGI ..... POA						<b>LIST PRICE</b>					
Can be used with all Floor Drain Bodies on this page and previous.						PIPE SIZE	30000-TSO				
						2" - 4"	\$403.00				
						<b>ADD FOR OPTIONS:</b>					
						-49 ..... \$0.00    -ARE ..... \$172.00 -50 ..... 0.00    -TSO ..... 0.00 -92 ..... 193.00					

	<b>30000-ST</b>		<b>BODY ASSEMBLY WITH SHALLOW THREADED OUTLET TRAP</b>	
	<b>LIST PRICE</b>			
	<b>PIPE SIZE</b>	<b>30000-ST</b>		
	2", 3"	\$633.00		
<b>ADD FOR OPTIONS:</b>				
-49.....	\$0.00	-ARE.....	\$172.00	
-50.....	STD	-TGI.....	POA	
-92.....	193.00	-Z.....	0.00	

	<b>30304-Z</b>		<b>NO-HUB CAST IRON BODY</b>	
	<b>LIST PRICE</b>			
	<b>PIPE SIZE</b>	<b>30304</b>		
4"	\$87.00			

	<b>30500</b>		<b>BODY ASSEMBLY WITH TRAP &amp; FLUSH WITH FLOOR CLEANOUT</b>	
	<b>LIST PRICE</b>			
	<b>PIPE SIZE</b>	<b>30500</b>		
	2" - 4"	\$1,118.00		
<b>ADD FOR OPTIONS:</b>				
-49.....	\$147.00	-60.....	\$376.00	
-50.....	147.00	-92.....	520.00	
-51.....	343.00	-C.....	0.00	
-52.....	343.00	-Z.....	0.00	

	<b>30802-4CP</b>		<b>BODY WITH 2" SHALLOW TRAP &amp; ROUND CHROME PLATED STRAINER</b>	
	<b>LIST PRICE</b>			
	<b>PIPE SIZE</b>	<b>30802-4CP</b>		
	2"	\$539.00		
<b>ADD FOR OPTIONS:</b>				
-LT.....	Deduct \$216.00	-T.....	\$0.00	
-SQ.....	65.00	-Z.....	0.00	

## ADJUSTABLE FLOOR DRAIN ASSEMBLIES







	<b>30900-9AD</b>		<b>BODY WITH 9" ROUND NIKALOY STRAINER</b>	
	<b>LIST PRICE</b>			
	<b>PIPE SIZE</b>	<b>30900-9AD</b>		
	2" - 4"	\$2,005.00		
<b>ADD FOR OPTIONS:</b>				
-2.....	Deduct \$205.00	-TGI.....	POA	
-66 (2", 3").....	216.00	-VP.....	53.00	
-66 (4").....	308.00	-X.....	0.00	
-92.....	193.00	-Y.....	0.00	
-T.....	77.00	-Z.....	0.00	

	<b>31000</b>		<b>BODY WITH 5" ROUND NIKALOY TOP</b>	
	<b>LIST PRICE</b>			
	<b>PIPE SIZE</b>	<b>31000</b>		
	2" - 4"	\$376.00		
<b>ADD FOR OPTIONS:</b>				
-C.....	\$32.00	-Y (2", 3").....	\$0.00	
-SQ.....	161.00	-Z (3", 4").....	0.00	
-TGI.....	POA			

OPTION DESCRIPTIONS	
<b>Strainers</b>	<b>Bodies Only</b>
-ARE Acid-Resisting Epoxy	-ARE Acid-Resisting Epoxy
-CP Chrome Plated	-C Bolted Flashing Clamp Device
-DBC Debris Cover	-CC4 Clamp Collar with 4" Thread
-HD Heavy-Duty Heel Proof (Nikaloy Only)	-MD PVC Clamp Collar with 3" Socket Connection
-J Backwater Valve	-PD Prison Drain
-LT Less Shallow Trap	-PFB Pre-Fabricated Base
-PF Perforated Standpipe	-ST Shallow Trap
-SC Solid Cover	-49 3/4" Primer Tap
-SS Stainless Steel	-50 1/2" Primer Tap
-SQ Square Top	-51 1-1/2" Threaded Auxiliary Inlet
-TGI Trap Guard Insert	-52 2" Threaded Auxiliary Inlet
-VP Secured Grate, Vandal-Proof Screws	-60 Backwater Valve
-2 Satin Finish Bronze	-91 Rough Bronze Body
-24 Less Dome	-92 Galvanized Cast Iron Parts
-80 Perforated Stainless Steel Basket	<b>Outlets</b>
-92 Galvanized Cast Iron	-T Threaded Outlet
-93 Cast Iron	-TSO Threaded Side Outlet
	-X Inside Caulk Outlet
	-Y Hub Outlet with Gasket
	-Z No-Hub Outlet

	<b>31300</b>		<b>BODY WITH INTEGRAL TRAP AND AUXILIARY INETS</b>	
	<b>LIST PRICE</b>			
	<b>PIPE SIZE</b>	<b>31300</b>		
	2" - 4"	\$836.00		
<b>ADD FOR OPTIONS:</b>				
-92.....	\$193.00	-ARE.....	\$172.00	





FLOOR DRAINS		
	<b>SUPER-FLO® 9" TOP</b>	
	LIST PRICE	
PIPE SIZE	32100	
2" - 4"	\$499.00	
6" (Z)	639.00	
ADD FOR OPTIONS:		
-1.....	\$496.00	-49..... \$161.00
-2.....	424.00	-50..... 161.00
-7.....	232.00	-66..... 427.00
-11.....	64.00	-81..... 92.00
-13.....	80.00	-84..... 286.00
-13-1.....	862.00	-88..... 41.00
-13-2.....	689.00	-92..... 422.00
-15.....	240.00	-AE..... 200.00
-39.....	481.00	-ARE..... 510.00
-44*.....	278.00	-HP..... 106.00
-44-92*.....	567.00	-HP-7..... 161.00
* Specify Height, Each 3" or Fraction † Available up to 4" only		
	<b>9" TRACTOR TOP</b>	
	LIST PRICE	
PIPE SIZE	32100-TG	
2" - 4"	\$619.00	
ADD FOR OPTIONS:		
-1.....	\$496.00	-66..... \$427.00
-2.....	424.00	-81..... 92.00
-7.....	232.00	-84..... 286.00
-15.....	240.00	-88..... 41.00
-44*.....	278.00	-92..... 422.00
-44-92*.....	567.00	-AE..... 200.00
-49.....	161.00	-ARE..... 510.00
-50.....	161.00	-PFB..... 277.00
* Specify Height, Each 3" or Fraction † Available up to 4" only		
	<b>SUPER-FLO® 9" BLOOD DRAIN</b>	
	LIST PRICE	
PIPE SIZE	32150	
2" - 4"	\$1,494.00	
ADD FOR OPTIONS:		
-1.....	\$2,741.00	-ARE..... \$1,023.00
-2.....	2,217.00	-T..... 77.00
-7.....	539.00	-TGI..... POA
-44*.....	364.00	-X..... 0.00
-44-92*.....	829.00	-Y..... 0.00
-92.....	838.00	-Z..... 0.00
* Specify Height, Each 3" or Fraction		
	<b>DEEP BODY, 9" TRACTOR TOP</b>	
	LIST PRICE	
PIPE SIZE	32160	
3", 4"	\$1,352.00	
ADD FOR OPTIONS:		
-7.....	\$187.00	-51..... \$343.00
-12.....	319.00	-52..... 343.00
-15.....	240.00	-53..... 460.00
-19.....	496.00	-54..... 460.00
-20.....	414.00	-53-92..... 523.00
-44*.....	278.00	-54-92..... 523.00
-49.....	147.00	-60..... 607.00
-50.....	147.00	-62 (3")▲..... 385.00
		-62 (4")▲..... 651.00
		-66..... \$367.00
		-71▲..... 187.00
		-81▲..... 187.00
		-88▲..... 53.00
		-92..... 556.00
		-ARE..... 923.00
		-HP..... 106.00
		-TGI..... POA
		-VP..... 187.00
		-X..... 0.00
* Specify Height, Each 3" or Fraction ▲ Cannot be installed when BWV is ordered.		
	<b>SHALLOW SUMP, SUPER-FLO® 12" TOP</b>	
	LIST PRICE	
PIPE SIZE	32200	
2" - 6" 8"	\$1,041.00 1,319.00	
ADD FOR OPTIONS:		
-1.....	\$744.00	-50..... \$147.00
-2.....	645.00	-66•..... 367.00
-4*.....	185.00	-81..... 455.00
-7.....	256.00	-84..... 414.00
-13.....	136.00	-88..... 64.00
-13-1.....	1,230.00	-92..... 638.00
-13-2.....	1,054.00	-AE..... 702.00
-15.....	235.00	-ARE..... 832.00
-44*.....	245.00	-HP..... 106.00
-44-92**.....	495.00	-HP-7..... 161.00
-49.....	147.00	-OR..... 702.00
		-SD..... \$92.00
		-SD-1..... 836.00
		-SD-2..... 737.00
		-T..... 77.00
		-TGI†..... POA
		-VP..... 146.00
		-X..... 0.00
		-Y..... 0.00
		-Z..... 0.00
* Available on -AE Only ** Specify Height, Each 3" or Fraction •2" - 6" † Available up to 4" only		
	<b>MEDIUM SUMP, SUPER-FLO® 12" TOP</b>	
	LIST PRICE	
PIPE SIZE	32300	
2" - 8"	\$1,260.00	
ADD FOR OPTIONS:		
-1.....	\$744.00	-49..... \$147.00
-2.....	645.00	-50..... 147.00
-7.....	256.00	-66•..... 367.00
-13.....	136.00	-81..... 249.00
-13-1.....	1,230.00	-84..... 414.00
-13-2.....	1,054.00	-88..... 64.00
-15.....	235.00	-92..... 638.00
-44*.....	245.00	-ARE..... 950.00
-44-92*.....	495.00	-HP..... 106.00
		-SD..... \$153.00
		-SD-19..... 1,471.00
		-SD-20•..... 1,426.00
		-TGI†..... POA
		-VP..... 146.00
		-X..... 0.00
		-Z..... 0.00
* Specify Height, Each 2" or Fraction •2" - 6" † Available up to 4" only		
	<b>DEEP SUMP, SUPER-FLO® 12" TOP w/BUCKET</b>	
	LIST PRICE	
PIPE SIZE	32330	
2" - 6" 8"	\$1,763.00 2,066.00	
ADD FOR OPTIONS:		
-15.....	\$235.00	-88..... \$92.00
-19.....	715.00	-92..... 1,190.00
-20.....	619.00	-SD..... 0.00
-49.....	161.00	-SD-19..... 1,471.00
-50.....	161.00	-SD-20•..... 1,426.00
-66•.....	367.00	-TGI†..... POA
-70.....	Deduct 299.00	-VP..... 146.00
-84.....	403.00	-X..... 0.00
		-Y..... 0.00
		-Z..... 0.00
* Specify Height, Each 3" or Fraction •2" - 6" † Available up to 4" only		

	<b>15" EXTRA HEAVY-DUTY TOP</b>	
	LIST PRICE	
	PIPE SIZE	34710
	4"	\$1,547.00
	5" & 6"	1,834.00
	8"	2,189.00
ADD FOR OPTIONS:		
-7.....	\$607.00	-88..... \$92.00
-15.....	235.00	-92..... 880.00
-19.....	1,815.00	-AE ..... 702.00
-20.....	1,586.00	-ARE ..... 917.00
-49.....	147.00	-T ..... 77.00
-50.....	147.00	-TGI† ..... POA
† Available up to 4" only		

	<b>15" EXTRA HEAVY-DUTY TOP WITH BUCKET</b>	
	LIST PRICE	
	PIPE SIZE	34720
	3" - 6"	\$2,902.00
ADD FOR OPTIONS:		
-7.....	\$651.00	-50..... \$147.00
-15.....	235.00	-66..... 367.00
-19.....	1,815.00	-84..... 414.00
-20.....	1,586.00	-88..... 92.00
-49.....	147.00	-92..... 1,949.00
† Available up to 4" only		

	<b>NON-CLOG 21" ROUND TOP WITH BUCKET</b>	
	LIST PRICE	
	PIPE SIZE	34920
	3" - 8"	\$15,120.00
ADD FOR OPTIONS:		
-12.....	*P.O.A.	-49..... \$147.00
-12-1 .....	*P.O.A.	-50..... 147.00
-12-2 .....	*P.O.A.	-66* ..... 367.00
-15.....	235.00	-80..... 2,773.00
-19.....	1,945.00	-84..... 556.00
-20.....	1,623.00	-92..... 2,910.00
* PRICE ON APPLICATION • 2" - 6"		
† Available up to 4" only		

	<b>8" SQUARE TOP</b>	
	LIST PRICE	
	PIPE SIZE	35100
	2" - 4"	\$816.00
ADD FOR OPTIONS:		
-1.....	\$607.00	-50..... STD
-2.....	450.00	-92..... 416.00
-7.....	207.00	-ARE ..... 496.00
-15.....	235.00	-T ..... 77.00
-49.....	161.00	-TGI ..... POA
		-TSO ..... \$216.00
		-X ..... 0.00
		-Y ..... 0.00
		-Z ..... 0.00

	<b>9" TOP WITH BUCKET</b>	
	LIST PRICE	
	PIPE SIZE	35130
	2" - 4"	\$952.00
ADD FOR OPTIONS:		
-1.....	\$619.00	-50..... \$147.00
-2.....	450.00	-66..... 153.00
-14-1 .....	1,630.00	-70.. Deduct 77.00
-14-2 .....	1,542.00	-84..... 205.00
-15.....	240.00	-92..... 420.00
-49.....	147.00	-ARE ..... 727.00
		-TGI ..... POA
		-VP ..... 147.00
		-X ..... 0.00
		-Z ..... 0.00









	<b>10" TRACTOR TOP WITH BUCKET</b>	
	LIST PRICE	
	PIPE SIZE	35170
	3", 4"	\$1,146.00
ADD FOR OPTIONS:		
-1.....	\$952.00	-70 Deduct \$95.00
-2.....	803.00	-84..... 270.00
-15.....	235.00	-88..... 53.00
-49.....	161.00	-92..... 341.00
-50.....	161.00	-TGI ..... POA
		-VP ..... \$147.00
		-X ..... 0.00
		-Z ..... 0.00





### OPTION DESCRIPTIONS







- AE LEVELEZE® Adjustable Extension
- ARE Acid Resisting Epoxy
- C Bolted Flashing Clamp Device
- HP Heel-Proof Grate
- HP-7 Heel-Proof Grate, Ductile Iron
- LC1 Locking Cover, Satin Finish Nikaloy
- LC2 Locking Cover, Satin Finish Bronze
- LT Less Shallow Trap
- OR LEVELEZE® Adjustable Extension with O-Ring
- PFB Pre-Fabricated Base
- SD Special Duty Grate
- SD-19 Special Duty, C.I. Undergrate with Satin Finish Nikaloy Top
- SD-20 Special Duty, C.I. Undergrate with Satin Finish Bronze Top
- SQ Square Top
- TG Tractor Grate
- TGI Trap Guard Insert
- VP Secured Grate, Vandal-Proof Screws
- 1 Satin Finish Nikaloy Top
- 2 Satin Finish Bronze Top
- 4 Secondary Flashing Clamp (use with -AE only)
- 7 Ductile Iron Grate
- 11 Extra-Heavy Grate, Cast Iron
- 12 Square Top, Cast Iron
- 12-1 Square Top, Nikaloy
- 12-2 Square Top, Bronze
- 13 Dome Grate, Cast Iron
- 13-1 Dome Grate, Nikaloy
- 13-2 Dome Grate, Bronze
- 14-1 Hinged Top, Satin Finish Nikaloy
- 14-2 Hinged Top, Satin Finish Bronze
- 15 Chained Grate
- 19 C.I. Undergrate with Satin Finish Nikaloy Top
- 20 C.I. Undergrate with Satin Finish Bronze Top
- 39 Solid Cast Iron Cover
- 44 Fixed Extension Collar, Cast Iron, Specify Height
- 44-92 Fixed Extension Collar, Galvanized, Specify Height
- 49 3/4" Primer Tap
- 50 1/2" Primer Tap
- 51 1-1/2" Auxiliary Threaded Inlet
- 52 2" Auxiliary Threaded Inlet
- 53 2" Auxiliary Hub Inlet
- 54 2" Auxiliary Spigot Inlet
- 53-92 2" Auxiliary Hub Inlet, Galvanized
- 54-92 2" Auxiliary Spigot Inlet, Galvanized
- 60 Backwater Valve
- 62 "T" Handle Bronze Closure Plug
- 70 Less Bucket
- 71 Solid Cast Iron Bucket
- 81 Slotted Cast Iron Bucket
- 84 Stainless Steel Mesh Bucket Liner
- 88 Supplementary Strainer
- 92 Galvanized Cast Iron Parts

### Outlets

- 66 No-Hub Side Outlet
- T Threaded Outlet
- TSO Threaded Side Outlet
- X Inside Caulk Outlet
- Y Hub Outlet with Gasket, 2" - 4"
- Z No-Hub Outlet

<p><b>37800</b></p> 	<p><b>SHALLOW SUMP, 12" HEAVY-DUTY TOP</b></p> <p><b>LIST PRICE</b></p> <table border="1"> <tr> <th>PIPE SIZE</th> <th>37800</th> </tr> <tr> <td>2" - 4"</td> <td>\$1,386.00</td> </tr> </table> <p><b>ADD FOR OPTIONS:</b></p> <table border="1"> <tr> <td>-7..... \$580.00</td> <td>-49..... \$161.00</td> <td>-TGI† ..... POA</td> </tr> <tr> <td>-14..... 235.00</td> <td>-50..... STD</td> <td>-VP ..... 143.00</td> </tr> <tr> <td>-18..... 543.00</td> <td>-66..... 212.00</td> <td>-X ..... 0.00</td> </tr> <tr> <td>-19..... 1,088.00</td> <td>-92..... 488.00</td> <td>-Y ..... 0.00</td> </tr> <tr> <td>-20..... 900.00</td> <td>-T..... 77.00</td> <td>-Z..... 0.00</td> </tr> </table>	PIPE SIZE	37800	2" - 4"	\$1,386.00	-7..... \$580.00	-49..... \$161.00	-TGI† ..... POA	-14..... 235.00	-50..... STD	-VP ..... 143.00	-18..... 543.00	-66..... 212.00	-X ..... 0.00	-19..... 1,088.00	-92..... 488.00	-Y ..... 0.00	-20..... 900.00	-T..... 77.00	-Z..... 0.00	<p><b>37900</b></p> 	<p><b>14" PACKING HOUSE DRAIN</b></p> <p><b>LIST PRICE</b></p> <table border="1"> <tr> <th>PIPE SIZE</th> <th>37900</th> </tr> <tr> <td>2" - 6"</td> <td>\$2,929.00</td> </tr> <tr> <td>8"</td> <td>3,301.00</td> </tr> </table> <p><b>ADD FOR OPTIONS:</b></p> <table border="1"> <tr> <td>-4..... \$185.00</td> <td>-84..... \$414.00</td> <td>-VP ..... \$146.00</td> </tr> <tr> <td>-15..... 240.00</td> <td>-88..... 75.00</td> <td>-X ..... 0.00</td> </tr> <tr> <td>-19..... 1,331.00</td> <td>-92..... 1,675.00</td> <td>-Y ..... 0.00</td> </tr> <tr> <td>-20..... 1,267.00</td> <td>-T..... 77.00</td> <td>-Z..... 0.00</td> </tr> <tr> <td>-70.... Ded. 180.00</td> <td>-TGI† ..... POA</td> <td></td> </tr> </table> <p>† Available up to 4" only</p>	PIPE SIZE	37900	2" - 6"	\$2,929.00	8"	3,301.00	-4..... \$185.00	-84..... \$414.00	-VP ..... \$146.00	-15..... 240.00	-88..... 75.00	-X ..... 0.00	-19..... 1,331.00	-92..... 1,675.00	-Y ..... 0.00	-20..... 1,267.00	-T..... 77.00	-Z..... 0.00	-70.... Ded. 180.00	-TGI† ..... POA															
PIPE SIZE	37800																																																								
2" - 4"	\$1,386.00																																																								
-7..... \$580.00	-49..... \$161.00	-TGI† ..... POA																																																							
-14..... 235.00	-50..... STD	-VP ..... 143.00																																																							
-18..... 543.00	-66..... 212.00	-X ..... 0.00																																																							
-19..... 1,088.00	-92..... 488.00	-Y ..... 0.00																																																							
-20..... 900.00	-T..... 77.00	-Z..... 0.00																																																							
PIPE SIZE	37900																																																								
2" - 6"	\$2,929.00																																																								
8"	3,301.00																																																								
-4..... \$185.00	-84..... \$414.00	-VP ..... \$146.00																																																							
-15..... 240.00	-88..... 75.00	-X ..... 0.00																																																							
-19..... 1,331.00	-92..... 1,675.00	-Y ..... 0.00																																																							
-20..... 1,267.00	-T..... 77.00	-Z..... 0.00																																																							
-70.... Ded. 180.00	-TGI† ..... POA																																																								
<p><b>37810</b></p> 	<p><b>MEDIUM SUMP, 12" HEAVY-DUTY TOP</b></p> <p><b>LIST PRICE</b></p> <table border="1"> <tr> <th>PIPE SIZE</th> <th>37810</th> </tr> <tr> <td>2" - 6"</td> <td>\$1,474.00</td> </tr> </table> <p><b>ADD FOR OPTIONS:</b></p> <table border="1"> <tr> <td>-4* ..... \$185.00</td> <td>-49..... \$147.00</td> <td>-AE ..... \$702.00</td> </tr> <tr> <td>-7..... 596.00</td> <td>-50..... 147.00</td> <td>-ARE ..... 911.00</td> </tr> <tr> <td>-14..... 235.00</td> <td>-66..... 367.00</td> <td>-T..... 77.00</td> </tr> <tr> <td>-18..... 543.00</td> <td>-70.... Ded. 164.00</td> <td>-TGI† ..... POA</td> </tr> <tr> <td>-19..... 1,088.00</td> <td>-84..... 414.00</td> <td>-VP ..... 143.00</td> </tr> <tr> <td>-20..... 900.00</td> <td>-88..... 92.00</td> <td>-X ..... 0.00</td> </tr> <tr> <td>-39..... 410.00</td> <td>-92..... 880.00</td> <td>-Y ..... 0.00</td> </tr> <tr> <td></td> <td></td> <td>-Z..... 0.00</td> </tr> </table> <p>* Available on -AE only † Available up to 4" only</p>	PIPE SIZE	37810	2" - 6"	\$1,474.00	-4* ..... \$185.00	-49..... \$147.00	-AE ..... \$702.00	-7..... 596.00	-50..... 147.00	-ARE ..... 911.00	-14..... 235.00	-66..... 367.00	-T..... 77.00	-18..... 543.00	-70.... Ded. 164.00	-TGI† ..... POA	-19..... 1,088.00	-84..... 414.00	-VP ..... 143.00	-20..... 900.00	-88..... 92.00	-X ..... 0.00	-39..... 410.00	-92..... 880.00	-Y ..... 0.00			-Z..... 0.00	<p><b>37960</b></p> 	<p><b>SUPER-FLO® 16" TOP</b></p> <p><b>LIST PRICE</b></p> <table border="1"> <tr> <th>PIPE SIZE</th> <th>37960</th> </tr> <tr> <td>2" - 6"</td> <td>\$2,520.00</td> </tr> </table> <p><b>ADD FOR OPTIONS:</b></p> <table border="1"> <tr> <td>-1..... \$2,917.00</td> <td>-81..... \$582.00</td> <td>-LF ... Ded. \$369.00</td> </tr> <tr> <td>-2..... 2,620.00</td> <td>-84..... 414.00</td> <td>-LG.... Ded. 560.00</td> </tr> <tr> <td>-7..... 601.00</td> <td>-92..... 1,246.00</td> <td>-LG-1. Ded. 1,170.00</td> </tr> <tr> <td>-11..... 601.00</td> <td>-92-LF... 1,048.00</td> <td>-LG-2. Ded. 1,090.00</td> </tr> <tr> <td>-15..... 240.00</td> <td>-92-LG-LF... 952.00</td> <td>-TGI† ..... POA</td> </tr> <tr> <td>-49..... 187.00</td> <td>-ARE .... See 49400</td> <td>-VP* ..... 75.00</td> </tr> <tr> <td>-50..... 187.00</td> <td>-C ..... 556.00</td> <td>-X..... 0.00</td> </tr> </table> <p>† Available up to 4" only * Only available with -1 or -2</p>	PIPE SIZE	37960	2" - 6"	\$2,520.00	-1..... \$2,917.00	-81..... \$582.00	-LF ... Ded. \$369.00	-2..... 2,620.00	-84..... 414.00	-LG.... Ded. 560.00	-7..... 601.00	-92..... 1,246.00	-LG-1. Ded. 1,170.00	-11..... 601.00	-92-LF... 1,048.00	-LG-2. Ded. 1,090.00	-15..... 240.00	-92-LG-LF... 952.00	-TGI† ..... POA	-49..... 187.00	-ARE .... See 49400	-VP* ..... 75.00	-50..... 187.00	-C ..... 556.00	-X..... 0.00	
PIPE SIZE	37810																																																								
2" - 6"	\$1,474.00																																																								
-4* ..... \$185.00	-49..... \$147.00	-AE ..... \$702.00																																																							
-7..... 596.00	-50..... 147.00	-ARE ..... 911.00																																																							
-14..... 235.00	-66..... 367.00	-T..... 77.00																																																							
-18..... 543.00	-70.... Ded. 164.00	-TGI† ..... POA																																																							
-19..... 1,088.00	-84..... 414.00	-VP ..... 143.00																																																							
-20..... 900.00	-88..... 92.00	-X ..... 0.00																																																							
-39..... 410.00	-92..... 880.00	-Y ..... 0.00																																																							
		-Z..... 0.00																																																							
PIPE SIZE	37960																																																								
2" - 6"	\$2,520.00																																																								
-1..... \$2,917.00	-81..... \$582.00	-LF ... Ded. \$369.00																																																							
-2..... 2,620.00	-84..... 414.00	-LG.... Ded. 560.00																																																							
-7..... 601.00	-92..... 1,246.00	-LG-1. Ded. 1,170.00																																																							
-11..... 601.00	-92-LF... 1,048.00	-LG-2. Ded. 1,090.00																																																							
-15..... 240.00	-92-LG-LF... 952.00	-TGI† ..... POA																																																							
-49..... 187.00	-ARE .... See 49400	-VP* ..... 75.00																																																							
-50..... 187.00	-C ..... 556.00	-X..... 0.00																																																							
<p><b>37820</b></p> 	<p><b>DEEP SUMP, 12" HEAVY-DUTY TOP WITH BUCKET</b></p> <p><b>LIST PRICE</b></p> <table border="1"> <tr> <th>PIPE SIZE</th> <th>37820</th> </tr> <tr> <td>2" - 8"</td> <td>\$1,694.00</td> </tr> </table> <p><b>ADD FOR OPTIONS:</b></p> <table border="1"> <tr> <td>-4* ..... \$185.00</td> <td>-49..... \$147.00</td> <td>-AE ..... \$702.00</td> </tr> <tr> <td>-7..... 596.00</td> <td>-50..... 147.00</td> <td>-ARE ..... 964.00</td> </tr> <tr> <td>-14..... 235.00</td> <td>-66* ..... 367.00</td> <td>-TGI† ..... POA</td> </tr> <tr> <td>-18..... 543.00</td> <td>-70.... Ded. 164.00</td> <td>-VP ..... 143.00</td> </tr> <tr> <td>-19..... 1,088.00</td> <td>-84..... 414.00</td> <td>-X ..... 0.00</td> </tr> <tr> <td>-20..... 900.00</td> <td>-88..... 92.00</td> <td>-Z..... 0.00</td> </tr> <tr> <td>-39..... 410.00</td> <td>-92..... 880.00</td> <td></td> </tr> </table> <p>* Available on -AE only † Available up to 4" only</p>	PIPE SIZE	37820	2" - 8"	\$1,694.00	-4* ..... \$185.00	-49..... \$147.00	-AE ..... \$702.00	-7..... 596.00	-50..... 147.00	-ARE ..... 964.00	-14..... 235.00	-66* ..... 367.00	-TGI† ..... POA	-18..... 543.00	-70.... Ded. 164.00	-VP ..... 143.00	-19..... 1,088.00	-84..... 414.00	-X ..... 0.00	-20..... 900.00	-88..... 92.00	-Z..... 0.00	-39..... 410.00	-92..... 880.00		<p><b>38040</b></p> 	<p><b>ROUND TOP &amp; CLEANOUT</b></p> <p><b>LIST PRICE</b></p> <table border="1"> <tr> <th>PIPE SIZE</th> <th>38040</th> </tr> <tr> <td>2"</td> <td>\$1,243.00</td> </tr> <tr> <td>3"</td> <td>1,955.00</td> </tr> <tr> <td>4"</td> <td>2,053.00</td> </tr> </table> <p><b>ADD FOR OPTIONS:</b></p> <table border="1"> <tr> <td>-1..... \$755.00</td> <td>-51..... \$343.00</td> <td>-84..... \$286.00</td> </tr> <tr> <td>-2..... 692.00</td> <td>-52..... 343.00</td> <td>-88..... 41.00</td> </tr> <tr> <td>-7..... 249.00</td> <td>-60* (2") .. 595.00</td> <td>-92..... 744.00</td> </tr> <tr> <td>-11..... 64.00</td> <td>-60* (3") .. 656.00</td> <td>-TGI ..... POA</td> </tr> <tr> <td>-15..... 232.00</td> <td>-60* (4") .. 715.00</td> <td>-VP ..... 143.00</td> </tr> <tr> <td>-49..... 147.00</td> <td>-81..... 123.00</td> <td>-Z..... 0.00</td> </tr> <tr> <td>-50..... 147.00</td> <td>-81-92 ..... 207.00</td> <td></td> </tr> </table> <p>* Can not be used with TGI</p>	PIPE SIZE	38040	2"	\$1,243.00	3"	1,955.00	4"	2,053.00	-1..... \$755.00	-51..... \$343.00	-84..... \$286.00	-2..... 692.00	-52..... 343.00	-88..... 41.00	-7..... 249.00	-60* (2") .. 595.00	-92..... 744.00	-11..... 64.00	-60* (3") .. 656.00	-TGI ..... POA	-15..... 232.00	-60* (4") .. 715.00	-VP ..... 143.00	-49..... 147.00	-81..... 123.00	-Z..... 0.00	-50..... 147.00	-81-92 ..... 207.00	
PIPE SIZE	37820																																																								
2" - 8"	\$1,694.00																																																								
-4* ..... \$185.00	-49..... \$147.00	-AE ..... \$702.00																																																							
-7..... 596.00	-50..... 147.00	-ARE ..... 964.00																																																							
-14..... 235.00	-66* ..... 367.00	-TGI† ..... POA																																																							
-18..... 543.00	-70.... Ded. 164.00	-VP ..... 143.00																																																							
-19..... 1,088.00	-84..... 414.00	-X ..... 0.00																																																							
-20..... 900.00	-88..... 92.00	-Z..... 0.00																																																							
-39..... 410.00	-92..... 880.00																																																								
PIPE SIZE	38040																																																								
2"	\$1,243.00																																																								
3"	1,955.00																																																								
4"	2,053.00																																																								
-1..... \$755.00	-51..... \$343.00	-84..... \$286.00																																																							
-2..... 692.00	-52..... 343.00	-88..... 41.00																																																							
-7..... 249.00	-60* (2") .. 595.00	-92..... 744.00																																																							
-11..... 64.00	-60* (3") .. 656.00	-TGI ..... POA																																																							
-15..... 232.00	-60* (4") .. 715.00	-VP ..... 143.00																																																							
-49..... 147.00	-81..... 123.00	-Z..... 0.00																																																							
-50..... 147.00	-81-92 ..... 207.00																																																								
<p><b>37830</b></p> 	<p><b>12" TOP WITH LATCHING GRATE</b></p> <p><b>LIST PRICE</b></p> <table border="1"> <tr> <th>PIPE SIZE</th> <th>37830</th> </tr> <tr> <td>2" - 6"</td> <td>\$2,019.00</td> </tr> </table> <p><b>ADD FOR OPTIONS:</b></p> <table border="1"> <tr> <td>-7..... \$596.00</td> <td>-39..... \$ 410.00</td> <td>-84..... \$414.00</td> </tr> <tr> <td>-19..... 1,088.00</td> <td>-49..... 147.00</td> <td>-92..... 880.00</td> </tr> <tr> <td>-20..... 900.00</td> <td>-50..... 147.00</td> <td>-TGI† ..... POA</td> </tr> <tr> <td>-21.... Ded. 464.00</td> <td>-66..... 367.00</td> <td>-X ..... 0.00</td> </tr> <tr> <td>-22.... Ded. 308.00</td> <td>-69..... 77.00</td> <td>-Z..... 0.00</td> </tr> </table> <p>† Available up to 4" only</p>	PIPE SIZE	37830	2" - 6"	\$2,019.00	-7..... \$596.00	-39..... \$ 410.00	-84..... \$414.00	-19..... 1,088.00	-49..... 147.00	-92..... 880.00	-20..... 900.00	-50..... 147.00	-TGI† ..... POA	-21.... Ded. 464.00	-66..... 367.00	-X ..... 0.00	-22.... Ded. 308.00	-69..... 77.00	-Z..... 0.00	<p><b>38250A</b></p> 	<p><b>ROUND TOP WITH CLEANOUT &amp; BWV</b></p> <p><b>LIST PRICE</b></p> <table border="1"> <tr> <th>PIPE SIZE</th> <th>38250A</th> </tr> <tr> <td>2"</td> <td>838.00</td> </tr> <tr> <td>3"</td> <td>1,150.00</td> </tr> <tr> <td>4"</td> <td>1,615.00</td> </tr> </table> <p><b>ADD FOR OPTIONS:</b></p> <table border="1"> <tr> <td>-1 (2" - 3")..... \$409.00</td> <td>-61 (2") ..... Deduct \$92.00</td> </tr> <tr> <td>-1 (4") ..... 964.00</td> <td>-61 (3", 4")... Deduct 189.00</td> </tr> <tr> <td>-2 (2" - 3")..... 369.00</td> <td>-92..... 483.00</td> </tr> <tr> <td>-2 (4") ..... 870.00</td> <td>-VP ..... 143.00</td> </tr> <tr> <td>-15..... 235.00</td> <td>-Z..... 0.00</td> </tr> </table>	PIPE SIZE	38250A	2"	838.00	3"	1,150.00	4"	1,615.00	-1 (2" - 3")..... \$409.00	-61 (2") ..... Deduct \$92.00	-1 (4") ..... 964.00	-61 (3", 4")... Deduct 189.00	-2 (2" - 3")..... 369.00	-92..... 483.00	-2 (4") ..... 870.00	-VP ..... 143.00	-15..... 235.00	-Z..... 0.00																	
PIPE SIZE	37830																																																								
2" - 6"	\$2,019.00																																																								
-7..... \$596.00	-39..... \$ 410.00	-84..... \$414.00																																																							
-19..... 1,088.00	-49..... 147.00	-92..... 880.00																																																							
-20..... 900.00	-50..... 147.00	-TGI† ..... POA																																																							
-21.... Ded. 464.00	-66..... 367.00	-X ..... 0.00																																																							
-22.... Ded. 308.00	-69..... 77.00	-Z..... 0.00																																																							
PIPE SIZE	38250A																																																								
2"	838.00																																																								
3"	1,150.00																																																								
4"	1,615.00																																																								
-1 (2" - 3")..... \$409.00	-61 (2") ..... Deduct \$92.00																																																								
-1 (4") ..... 964.00	-61 (3", 4")... Deduct 189.00																																																								
-2 (2" - 3")..... 369.00	-92..... 483.00																																																								
-2 (4") ..... 870.00	-VP ..... 143.00																																																								
-15..... 235.00	-Z..... 0.00																																																								
<p><b>37840</b></p> 	<p><b>12" TOP WITH BUCKET</b></p> <p><b>LIST PRICE</b></p> <table border="1"> <tr> <th>PIPE SIZE</th> <th>37840</th> </tr> <tr> <td>2" - 8"</td> <td>\$2,929.00</td> </tr> </table> <p><b>ADD FOR OPTIONS:</b></p> <table border="1"> <tr> <td>-7..... \$596.00</td> <td>-50..... \$147.00</td> <td>-TGI† ..... POA</td> </tr> <tr> <td>-14..... 235.00</td> <td>-66* ..... 367.00</td> <td>-VP ..... 143.00</td> </tr> <tr> <td>-19..... 1,088.00</td> <td>-70.... Ded. 164.00</td> <td>-X ..... 0.00</td> </tr> <tr> <td>-20..... 900.00</td> <td>-84..... 414.00</td> <td>-Z..... 0.00</td> </tr> <tr> <td>-39..... 410.00</td> <td>-88..... 92.00</td> <td></td> </tr> <tr> <td>-49..... 147.00</td> <td>-92..... 880.00</td> <td></td> </tr> </table> <p>• 2" - 6" † Available up to 4" only</p>	PIPE SIZE	37840	2" - 8"	\$2,929.00	-7..... \$596.00	-50..... \$147.00	-TGI† ..... POA	-14..... 235.00	-66* ..... 367.00	-VP ..... 143.00	-19..... 1,088.00	-70.... Ded. 164.00	-X ..... 0.00	-20..... 900.00	-84..... 414.00	-Z..... 0.00	-39..... 410.00	-88..... 92.00		-49..... 147.00	-92..... 880.00																																			
PIPE SIZE	37840																																																								
2" - 8"	\$2,929.00																																																								
-7..... \$596.00	-50..... \$147.00	-TGI† ..... POA																																																							
-14..... 235.00	-66* ..... 367.00	-VP ..... 143.00																																																							
-19..... 1,088.00	-70.... Ded. 164.00	-X ..... 0.00																																																							
-20..... 900.00	-84..... 414.00	-Z..... 0.00																																																							
-39..... 410.00	-88..... 92.00																																																								
-49..... 147.00	-92..... 880.00																																																								

	<b>38420</b> <b>NON-CLOG WITH CLEANOUT &amp; BUCKET</b>			<b>22" X 14" TOP, INTERNAL DOME STRAINER</b>	
	<b>LIST PRICE</b>			<b>LIST PRICE</b>	
<b>PIPE SIZE</b>	<b>38420</b>		<b>PIPE SIZE</b>	<b>38850</b>	
3", 4"	\$15,818.00		3" - 6"	\$6,083.00	
<b>ADD FOR OPTIONS:</b>					
-1.....	\$3,951.00	-92.....	\$3,436.00	-7.....	\$1,955.00
-2.....	3,552.00	-C.....	526.00	-15.....	240.00
-15.....	240.00	-IGS.....	18,832.00	-92.....	3,262.00
-60.....	964.00	-VP.....	235.00	-TGI†.....	POA
-84.....	414.00			-VP.....	235.00
				-X.....	0.00
† Available up to 4" only					
	<b>38620-40</b> <b>13" X 11" TOP WITH HINGED GRATE</b>			<b>21" X 14 1/2" TOP, CLEANOUT &amp; BUCKET</b>	
	<b>LIST PRICE</b>			<b>LIST PRICE</b>	
<b>PIPE SIZE</b>	<b>38620-40</b>		<b>PIPE SIZE</b>	<b>38930</b>	
3"	\$4,846.00		3", 4"	\$3,519.00	
4"	5,342.00		<b>ADD FOR OPTIONS:</b>		
-1 (3")..	\$1,454.00	-33.....	\$367.00	-70..Ded.	\$164.00
-1 (4")...	1,582.00	-49.....	147.00	-84.....	414.00
-2 (3")...	1,180.00	-50.....	147.00	-92.....	1,890.00
-2 (4")...	1,302.00	-60* (3")..	659.00	-TGI.....	POA
-7.....	601.00	-60* (4")..	717.00	-VP.....	143.00
*Can not be used with TGI					
	<b>38640</b> <b>13" X 11" TOP WITH BUCKET</b>		<b>OPTION DESCRIPTIONS</b>		
	<b>LIST PRICE</b>		<b>-AE</b> LEVELEZE® Adjustable Extension		
<b>PIPE SIZE</b>	<b>38640</b>		<b>-ARE</b> Acid Resisting Epoxy		
2" - 4"	\$2,207.00		<b>-C</b> Bolted Flashing Clamp Device		
<b>ADD FOR OPTIONS:</b>			<b>-IGS</b> Internal Gas Seal		
-1.....	\$1,329.00	-84.....	\$414.00	<b>-LF</b> Less Double Drainage Flange	
-2.....	1,102.00	-92.....	988.00	<b>-LG</b> Less Grate, Cast Iron	
-7.....	607.00	-VP.....	146.00	<b>-LG-1</b> Less Grate, Nikaloy	
-70.....	Ded. 157.00			<b>-LG-2</b> Less Grate, Bronze	
				<b>-TGI</b> Trap Guard Insert	
				<b>-VP</b> Secured Grate, Vandal-Proof Screws	
				<b>-1</b> Satin Finish Nikaloy Top	
				<b>-2</b> Satin Finish Bronze Top	
				<b>-4</b> Secondary Flashing Clamp (use with -AE only)	
				<b>-7</b> Ductile Iron Grate	
				<b>-11</b> Extra-Heavy Grate, Cast Iron	
				<b>-14</b> Hinged Grate	
				<b>-15</b> Chained Grate	
				<b>-18</b> Hinged Grate with Latching Device	
				<b>-19</b> C.I. Undergrate with Satin Finish Nikaloy Top	
				<b>-20</b> C.I. Undergrate with Satin Finish Bronze Top	
				<b>-21</b> Loose-Set Grate	
				<b>-22</b> Less Latching Device	
				<b>-33</b> Galvanized Bucket Only	
				<b>-39</b> Solid Cast Iron Cover	
				<b>-49</b> 3/4" Primer Tap	
				<b>-50</b> 1/2" Primer Tap	
				<b>-51</b> 1-1/2" Auxiliary Threaded Inlet	
				<b>-52</b> 2" Auxiliary Threaded Inlet	
				<b>-60</b> Backwater Valve	
				<b>-61</b> Less Backwater Valve	
				<b>-69</b> Lift Handle for Sediment Bucket	
				<b>-70</b> Less Bucket	
				<b>-74</b> Aluminum Bucket	
				<b>-81</b> Slotted Cast Iron Bucket	
				<b>-81-92</b> Slotted Cast Iron Bucket, Galvanized	
				<b>-84</b> Stainless Steel Mesh Bucket Liner	
				<b>-88</b> Supplementary Strainer	
				<b>-92</b> Galvanized Cast Iron Parts	
				<b>-92-LF</b> Galv. C.I. Parts, Less Double Drainage Flange	
				<b>-92-LG-LF</b> Galv. C.I. Parts, Less Grate and Flange	
				<b>Outlets</b>	
				<b>-66</b> No-Hub Side Outlet	
				<b>-T</b> Threaded Outlet	
				<b>-X</b> Inside Caulk Outlet	
				<b>-Y</b> Hub Outlet with Gasket, 2" - 4"	
				<b>-Z</b> No-Hub Outlet	

 <p><b>39240</b></p>	<p align="center"><b>SQUARE CAN WASH DRAIN</b></p> <p align="center">LIST PRICE</p> <table border="1"> <thead> <tr> <th>PIPE SIZE</th> <th>39240</th> </tr> </thead> <tbody> <tr> <td>3" - 4"</td> <td>\$2,793.00</td> </tr> </tbody> </table> <p>ADD FOR OPTIONS:</p> <table border="0"> <tr> <td>-1..... \$787.00</td> <td>-C..... \$0.00</td> <td>-92..... \$1,023.00</td> </tr> <tr> <td>-2..... 692.00</td> <td>-TGI..... POA</td> <td>-X..... 0.00</td> </tr> <tr> <td>-15..... 240.00</td> <td>-66..... 367.00</td> <td>-Z..... 0.00</td> </tr> <tr> <td></td> <td>-84..... 464.00</td> <td></td> </tr> </table>	PIPE SIZE	39240	3" - 4"	\$2,793.00	-1..... \$787.00	-C..... \$0.00	-92..... \$1,023.00	-2..... 692.00	-TGI..... POA	-X..... 0.00	-15..... 240.00	-66..... 367.00	-Z..... 0.00		-84..... 464.00		 <p><b>49300</b></p>	<p align="center"><b>SUPER-FLO® 8" SQUARE TOP, 6" DEEP</b></p> <p align="center">LIST PRICE</p> <table border="1"> <thead> <tr> <th>PIPE SIZE</th> <th>49300</th> <th>49300 -LF</th> <th>49300 -NB</th> <th>49300 -LF-NB</th> </tr> </thead> <tbody> <tr> <td>2" - 4"</td> <td>\$1,742.00</td> <td>\$1,562.00</td> <td>\$2,166.00</td> <td>\$1,986.00</td> </tr> </tbody> </table> <p>ADD FOR OPTIONS:</p> <table border="0"> <tr> <td>-3..... \$0.00</td> <td>-35* ..... \$464.00</td> </tr> <tr> <td>-4..... 0.00</td> <td>-43..... 310.00</td> </tr> <tr> <td>-7..... 176.00</td> <td>-45..... Deduct 59.00</td> </tr> <tr> <td>-8..... 187.00</td> <td>-55** ..... 187.00</td> </tr> <tr> <td>-16 (ARE)..... 375.00</td> <td>-C..... 146.00</td> </tr> <tr> <td>-16 (NB)..... 420.00</td> <td>-HG..... 349.00</td> </tr> <tr> <td>-17 (ARE)..... 483.00</td> <td>-LF..... Deduct 180.00</td> </tr> <tr> <td>-17 (NB)..... 620.00</td> <td>-LG (ARE) ..... Deduct 187.00</td> </tr> <tr> <td>-18 (ARE)..... 523.00</td> <td>-LG (NB) ..... Deduct 299.00</td> </tr> <tr> <td>-18 (NB)..... 871.00</td> <td>-NB..... 424.00</td> </tr> <tr> <td>-20 (NB)..... 223.00</td> <td>-TGI..... POA</td> </tr> <tr> <td>-24 (NB)..... 212.00</td> <td>-VP (NB) ..... 75.00</td> </tr> <tr> <td>-31..... 199.00</td> <td>-X..... 0.00</td> </tr> <tr> <td>-33..... 424.00</td> <td>-Z..... 0.00</td> </tr> </table> <p>* Specify -31 or -33 Bucket ** 88450 Provided</p>	PIPE SIZE	49300	49300 -LF	49300 -NB	49300 -LF-NB	2" - 4"	\$1,742.00	\$1,562.00	\$2,166.00	\$1,986.00	-3..... \$0.00	-35* ..... \$464.00	-4..... 0.00	-43..... 310.00	-7..... 176.00	-45..... Deduct 59.00	-8..... 187.00	-55** ..... 187.00	-16 (ARE)..... 375.00	-C..... 146.00	-16 (NB)..... 420.00	-HG..... 349.00	-17 (ARE)..... 483.00	-LF..... Deduct 180.00	-17 (NB)..... 620.00	-LG (ARE) ..... Deduct 187.00	-18 (ARE)..... 523.00	-LG (NB) ..... Deduct 299.00	-18 (NB)..... 871.00	-NB..... 424.00	-20 (NB)..... 223.00	-TGI..... POA	-24 (NB)..... 212.00	-VP (NB) ..... 75.00	-31..... 199.00	-X..... 0.00	-33..... 424.00	-Z..... 0.00																																																
PIPE SIZE	39240																																																																																																								
3" - 4"	\$2,793.00																																																																																																								
-1..... \$787.00	-C..... \$0.00	-92..... \$1,023.00																																																																																																							
-2..... 692.00	-TGI..... POA	-X..... 0.00																																																																																																							
-15..... 240.00	-66..... 367.00	-Z..... 0.00																																																																																																							
	-84..... 464.00																																																																																																								
PIPE SIZE	49300	49300 -LF	49300 -NB	49300 -LF-NB																																																																																																					
2" - 4"	\$1,742.00	\$1,562.00	\$2,166.00	\$1,986.00																																																																																																					
-3..... \$0.00	-35* ..... \$464.00																																																																																																								
-4..... 0.00	-43..... 310.00																																																																																																								
-7..... 176.00	-45..... Deduct 59.00																																																																																																								
-8..... 187.00	-55** ..... 187.00																																																																																																								
-16 (ARE)..... 375.00	-C..... 146.00																																																																																																								
-16 (NB)..... 420.00	-HG..... 349.00																																																																																																								
-17 (ARE)..... 483.00	-LF..... Deduct 180.00																																																																																																								
-17 (NB)..... 620.00	-LG (ARE) ..... Deduct 187.00																																																																																																								
-18 (ARE)..... 523.00	-LG (NB) ..... Deduct 299.00																																																																																																								
-18 (NB)..... 871.00	-NB..... 424.00																																																																																																								
-20 (NB)..... 223.00	-TGI..... POA																																																																																																								
-24 (NB)..... 212.00	-VP (NB) ..... 75.00																																																																																																								
-31..... 199.00	-X..... 0.00																																																																																																								
-33..... 424.00	-Z..... 0.00																																																																																																								
 <p><b>39600</b></p>	<p align="center"><b>PLANTING AREA DRAIN</b></p> <p align="center">LIST PRICE</p> <table border="1"> <thead> <tr> <th>PIPE SIZE</th> <th>39600</th> </tr> </thead> <tbody> <tr> <td>2" - 6"</td> <td>\$1,081.00</td> </tr> </tbody> </table> <p>ADD FOR OPTIONS:</p> <table border="0"> <tr> <td>-66..... \$367.00</td> <td>-T..... \$77.00</td> <td>-Z..... \$0.00</td> </tr> <tr> <td>-89..... 147.00</td> <td>-TGI†..... POA</td> <td></td> </tr> <tr> <td>-92..... 388.00</td> <td>-X..... 0.00</td> <td></td> </tr> </table> <p>† Available up to 4" only</p>	PIPE SIZE	39600	2" - 6"	\$1,081.00	-66..... \$367.00	-T..... \$77.00	-Z..... \$0.00	-89..... 147.00	-TGI†..... POA		-92..... 388.00	-X..... 0.00																																																																																												
PIPE SIZE	39600																																																																																																								
2" - 6"	\$1,081.00																																																																																																								
-66..... \$367.00	-T..... \$77.00	-Z..... \$0.00																																																																																																							
-89..... 147.00	-TGI†..... POA																																																																																																								
-92..... 388.00	-X..... 0.00																																																																																																								
 <p><b>39720</b></p>	<p align="center"><b>11" TOP COMPOSITION DECK FLANGE</b></p> <p align="center">LIST PRICE</p> <table border="1"> <thead> <tr> <th>PIPE SIZE</th> <th>39720</th> </tr> </thead> <tbody> <tr> <td>2" - 4"</td> <td>\$1,999.00</td> </tr> </tbody> </table> <p>ADD FOR OPTIONS:</p> <table border="0"> <tr> <td>-1..... \$747.00</td> <td>-13-2 ... \$1,054.00</td> <td>-84..... \$464.00</td> </tr> <tr> <td>-2..... 651.00</td> <td>-15..... 240.00</td> <td>-92..... 900.00</td> </tr> <tr> <td>-7..... 260.00</td> <td>-TGI..... POA</td> <td>-T..... 77.00</td> </tr> <tr> <td>-13..... 136.00</td> <td>-VP..... 146.00</td> <td>-X..... 0.00</td> </tr> <tr> <td>-13-1 ..... 1,230.00</td> <td>-70....Ded. 308.00</td> <td></td> </tr> </table>	PIPE SIZE	39720	2" - 4"	\$1,999.00	-1..... \$747.00	-13-2 ... \$1,054.00	-84..... \$464.00	-2..... 651.00	-15..... 240.00	-92..... 900.00	-7..... 260.00	-TGI..... POA	-T..... 77.00	-13..... 136.00	-VP..... 146.00	-X..... 0.00	-13-1 ..... 1,230.00	-70....Ded. 308.00		 <p><b>49320A</b></p>	<p align="center"><b>12" SQUARE TOP, 6" DEEP</b></p> <p align="center">LIST PRICE</p> <table border="1"> <thead> <tr> <th>PIPE SIZE</th> <th>49320A</th> <th>49320A -LF</th> <th>49320A -NB</th> <th>49320A -LF-NB</th> </tr> </thead> <tbody> <tr> <td>2", 3" 4", 6"</td> <td>\$2,476.00</td> <td>\$2,094.00</td> <td>\$3,223.00</td> <td>\$2,841.00</td> </tr> </tbody> </table> <p>ADD FOR OPTIONS:</p> <table border="0"> <tr> <td>-3..... \$0.00</td> <td>-35* ..... \$464.00</td> </tr> <tr> <td>-4..... 0.00</td> <td>-43..... 334.00</td> </tr> <tr> <td>-5..... 1,078.00</td> <td>-45..... Deduct 59.00</td> </tr> <tr> <td>-7..... 176.00</td> <td>-55** ..... 187.00</td> </tr> <tr> <td>-8..... 187.00</td> <td>-C..... 185.00</td> </tr> <tr> <td>-15..... 3,469.00</td> <td>-LF..... Deduct 381.00</td> </tr> <tr> <td>-16 (ARE)..... 375.00</td> <td>-LG (ARE) ..... Deduct 224.00</td> </tr> <tr> <td>-16 (NB)..... 420.00</td> <td>-LG (NB) ..... Deduct 487.00</td> </tr> <tr> <td>-17 (ARE)..... 483.00</td> <td>-NB..... 747.00</td> </tr> <tr> <td>-17 (NB)..... 620.00</td> <td>-HG..... 349.00</td> </tr> <tr> <td>-18 (ARE)..... 523.00</td> <td>-TGI†..... POA</td> </tr> <tr> <td>-18 (NB)..... 871.00</td> <td>-VP (NB) ..... 75.00</td> </tr> <tr> <td>-20 (NB)..... 223.00</td> <td>-X..... 0.00</td> </tr> <tr> <td>-24 (NB)..... 212.00</td> <td>-Y (2" - 4") ..... 0.00</td> </tr> <tr> <td>-31..... 310.00</td> <td>-Z..... 0.00</td> </tr> <tr> <td>-33..... 595.00</td> <td></td> </tr> </table> <p>* Specify -31 or -33 Bucket ** 88450 Provided for 2" - 4". Body Primer Tapped for 6". † Available up to 4" only</p>	PIPE SIZE	49320A	49320A -LF	49320A -NB	49320A -LF-NB	2", 3" 4", 6"	\$2,476.00	\$2,094.00	\$3,223.00	\$2,841.00	-3..... \$0.00	-35* ..... \$464.00	-4..... 0.00	-43..... 334.00	-5..... 1,078.00	-45..... Deduct 59.00	-7..... 176.00	-55** ..... 187.00	-8..... 187.00	-C..... 185.00	-15..... 3,469.00	-LF..... Deduct 381.00	-16 (ARE)..... 375.00	-LG (ARE) ..... Deduct 224.00	-16 (NB)..... 420.00	-LG (NB) ..... Deduct 487.00	-17 (ARE)..... 483.00	-NB..... 747.00	-17 (NB)..... 620.00	-HG..... 349.00	-18 (ARE)..... 523.00	-TGI†..... POA	-18 (NB)..... 871.00	-VP (NB) ..... 75.00	-20 (NB)..... 223.00	-X..... 0.00	-24 (NB)..... 212.00	-Y (2" - 4") ..... 0.00	-31..... 310.00	-Z..... 0.00	-33..... 595.00																																										
PIPE SIZE	39720																																																																																																								
2" - 4"	\$1,999.00																																																																																																								
-1..... \$747.00	-13-2 ... \$1,054.00	-84..... \$464.00																																																																																																							
-2..... 651.00	-15..... 240.00	-92..... 900.00																																																																																																							
-7..... 260.00	-TGI..... POA	-T..... 77.00																																																																																																							
-13..... 136.00	-VP..... 146.00	-X..... 0.00																																																																																																							
-13-1 ..... 1,230.00	-70....Ded. 308.00																																																																																																								
PIPE SIZE	49320A	49320A -LF	49320A -NB	49320A -LF-NB																																																																																																					
2", 3" 4", 6"	\$2,476.00	\$2,094.00	\$3,223.00	\$2,841.00																																																																																																					
-3..... \$0.00	-35* ..... \$464.00																																																																																																								
-4..... 0.00	-43..... 334.00																																																																																																								
-5..... 1,078.00	-45..... Deduct 59.00																																																																																																								
-7..... 176.00	-55** ..... 187.00																																																																																																								
-8..... 187.00	-C..... 185.00																																																																																																								
-15..... 3,469.00	-LF..... Deduct 381.00																																																																																																								
-16 (ARE)..... 375.00	-LG (ARE) ..... Deduct 224.00																																																																																																								
-16 (NB)..... 420.00	-LG (NB) ..... Deduct 487.00																																																																																																								
-17 (ARE)..... 483.00	-NB..... 747.00																																																																																																								
-17 (NB)..... 620.00	-HG..... 349.00																																																																																																								
-18 (ARE)..... 523.00	-TGI†..... POA																																																																																																								
-18 (NB)..... 871.00	-VP (NB) ..... 75.00																																																																																																								
-20 (NB)..... 223.00	-X..... 0.00																																																																																																								
-24 (NB)..... 212.00	-Y (2" - 4") ..... 0.00																																																																																																								
-31..... 310.00	-Z..... 0.00																																																																																																								
-33..... 595.00																																																																																																									
 <p><b>39960</b></p>	<p align="center"><b>SQUARE TOP WITH HINGED GRATE</b></p> <p align="center">LIST PRICE</p> <table border="1"> <thead> <tr> <th>PIPE SIZE</th> <th>39960</th> </tr> </thead> <tbody> <tr> <td>2"</td> <td>\$376.00</td> </tr> <tr> <td>3"</td> <td>460.00</td> </tr> <tr> <td>4"</td> <td>787.00</td> </tr> </tbody> </table> <p>ADD FOR OPTIONS:</p> <table border="0"> <tr> <td>-VP..... \$146.00</td> <td>-92..... \$323.00</td> </tr> <tr> <td>-ARE..... 396.00</td> <td>-X..... 0.00</td> </tr> <tr> <td>-TGI..... POA</td> <td></td> </tr> </table>	PIPE SIZE	39960	2"	\$376.00	3"	460.00	4"	787.00	-VP..... \$146.00	-92..... \$323.00	-ARE..... 396.00	-X..... 0.00	-TGI..... POA																																																																																											
PIPE SIZE	39960																																																																																																								
2"	\$376.00																																																																																																								
3"	460.00																																																																																																								
4"	787.00																																																																																																								
-VP..... \$146.00	-92..... \$323.00																																																																																																								
-ARE..... 396.00	-X..... 0.00																																																																																																								
-TGI..... POA																																																																																																									
<p><b>Floor Drain</b></p> <p><b>OPTION DESCRIPTIONS</b></p> <table border="0"> <tr> <td>-ARE</td> <td>Acid Resisting Epoxy</td> </tr> <tr> <td>-C</td> <td>Bolted Flashing Clamp Device</td> </tr> <tr> <td>-TGI</td> <td>Trap Guard Insert</td> </tr> <tr> <td>-VP</td> <td>Secured Grate, Vandal-Proof Screws</td> </tr> <tr> <td>-1</td> <td>Satin Finish Nikaloy Top</td> </tr> <tr> <td>-2</td> <td>Satin Finish Bronze Top</td> </tr> <tr> <td>-7</td> <td>Ductile Iron Grate</td> </tr> <tr> <td>-13</td> <td>Dome Grate, Cast Iron</td> </tr> <tr> <td>-13-1</td> <td>Dome Grate, Nikaloy</td> </tr> <tr> <td>-13-2</td> <td>Dome Grate, Bronze</td> </tr> <tr> <td>-15</td> <td>Chained Grate</td> </tr> <tr> <td>-70</td> <td>Less Bucket</td> </tr> <tr> <td>-84</td> <td>Stainless Steel Mesh Bucket Liner</td> </tr> <tr> <td>-89</td> <td>Deck Clamp Assembly</td> </tr> <tr> <td>-92</td> <td>Galvanized Cast Iron Parts</td> </tr> </table> <p><b>Outlets</b></p> <table border="0"> <tr> <td>-66</td> <td>No-Hub Side Outlet</td> </tr> <tr> <td>-T</td> <td>Threaded Outlet</td> </tr> <tr> <td>-X</td> <td>Inside Caulk Outlet</td> </tr> <tr> <td>-Z</td> <td>No-Hub Outlet</td> </tr> </table>		-ARE	Acid Resisting Epoxy	-C	Bolted Flashing Clamp Device	-TGI	Trap Guard Insert	-VP	Secured Grate, Vandal-Proof Screws	-1	Satin Finish Nikaloy Top	-2	Satin Finish Bronze Top	-7	Ductile Iron Grate	-13	Dome Grate, Cast Iron	-13-1	Dome Grate, Nikaloy	-13-2	Dome Grate, Bronze	-15	Chained Grate	-70	Less Bucket	-84	Stainless Steel Mesh Bucket Liner	-89	Deck Clamp Assembly	-92	Galvanized Cast Iron Parts	-66	No-Hub Side Outlet	-T	Threaded Outlet	-X	Inside Caulk Outlet	-Z	No-Hub Outlet	<p align="center"><b>SANITARY FLOOR SINK OPTION DESCRIPTIONS</b></p> <table border="0"> <tr> <td>-C</td> <td>Clamp Device</td> <td>-20</td> <td>Solid Nikaloy Cover</td> </tr> <tr> <td>-LF</td> <td>Less Flange</td> <td>-24</td> <td>Chained Grate</td> </tr> <tr> <td>-LG</td> <td>Less Grate</td> <td>-31</td> <td>Sediment Bucket (Aluminum)</td> </tr> <tr> <td>-HG</td> <td>Hinged Grate (-NB Only)</td> <td>-32</td> <td>Shallow Sediment Bucket (Aluminum)</td> </tr> <tr> <td>-NB</td> <td>Nickel Bronze Traffic Top</td> <td>-33</td> <td>Sediment Bucket (A.R. Finish)</td> </tr> <tr> <td>-TGI</td> <td>Trap Guard Insert</td> <td>-35</td> <td>Stainless Steel Mesh Bucket Liner</td> </tr> <tr> <td>-VP</td> <td>Secured Grate, Vandal-Proof Screws</td> <td>-43</td> <td>Internal Dome Strainer (A.R. Finish)</td> </tr> <tr> <td>-3</td> <td>1/2 Grate</td> <td>-45</td> <td>Less Internal Dome Strainer</td> </tr> <tr> <td>-4</td> <td>3/4 Grate</td> <td>-51</td> <td>Galvanized Cast Iron Inside and Outside</td> </tr> <tr> <td>-5</td> <td>Nikaloy Extra Heavy-Duty Grate &amp; Rim (Not SUPER-FLO® Design)</td> <td>-52</td> <td>Painted Inside and Outside</td> </tr> <tr> <td>-7</td> <td>Full Grate with 2-1/2" Center Opening</td> <td>-55</td> <td>1/2" Primer Tap or Adapter</td> </tr> <tr> <td>-8</td> <td>Stainless Steel Depressed Grate</td> <td></td> <td></td> </tr> <tr> <td>-15</td> <td>Stainless Steel Rim and Grate</td> <td><b>Outlets</b></td> <td></td> </tr> <tr> <td>-16</td> <td>Grate with 4" Round Funnel</td> <td>-X</td> <td>Inside Caulk Outlet</td> </tr> <tr> <td>-17</td> <td>Grate with 6" Round Funnel</td> <td>-Y</td> <td>Hub Outlet w/Gasket 2" - 4"</td> </tr> <tr> <td>-18</td> <td>Grate with 9" x 3-1/2" Oval Funnel</td> <td>-Z</td> <td>No-Hub Outlet</td> </tr> </table>		-C	Clamp Device	-20	Solid Nikaloy Cover	-LF	Less Flange	-24	Chained Grate	-LG	Less Grate	-31	Sediment Bucket (Aluminum)	-HG	Hinged Grate (-NB Only)	-32	Shallow Sediment Bucket (Aluminum)	-NB	Nickel Bronze Traffic Top	-33	Sediment Bucket (A.R. Finish)	-TGI	Trap Guard Insert	-35	Stainless Steel Mesh Bucket Liner	-VP	Secured Grate, Vandal-Proof Screws	-43	Internal Dome Strainer (A.R. Finish)	-3	1/2 Grate	-45	Less Internal Dome Strainer	-4	3/4 Grate	-51	Galvanized Cast Iron Inside and Outside	-5	Nikaloy Extra Heavy-Duty Grate & Rim (Not SUPER-FLO® Design)	-52	Painted Inside and Outside	-7	Full Grate with 2-1/2" Center Opening	-55	1/2" Primer Tap or Adapter	-8	Stainless Steel Depressed Grate			-15	Stainless Steel Rim and Grate	<b>Outlets</b>		-16	Grate with 4" Round Funnel	-X	Inside Caulk Outlet	-17	Grate with 6" Round Funnel	-Y	Hub Outlet w/Gasket 2" - 4"	-18	Grate with 9" x 3-1/2" Oval Funnel	-Z	No-Hub Outlet
-ARE	Acid Resisting Epoxy																																																																																																								
-C	Bolted Flashing Clamp Device																																																																																																								
-TGI	Trap Guard Insert																																																																																																								
-VP	Secured Grate, Vandal-Proof Screws																																																																																																								
-1	Satin Finish Nikaloy Top																																																																																																								
-2	Satin Finish Bronze Top																																																																																																								
-7	Ductile Iron Grate																																																																																																								
-13	Dome Grate, Cast Iron																																																																																																								
-13-1	Dome Grate, Nikaloy																																																																																																								
-13-2	Dome Grate, Bronze																																																																																																								
-15	Chained Grate																																																																																																								
-70	Less Bucket																																																																																																								
-84	Stainless Steel Mesh Bucket Liner																																																																																																								
-89	Deck Clamp Assembly																																																																																																								
-92	Galvanized Cast Iron Parts																																																																																																								
-66	No-Hub Side Outlet																																																																																																								
-T	Threaded Outlet																																																																																																								
-X	Inside Caulk Outlet																																																																																																								
-Z	No-Hub Outlet																																																																																																								
-C	Clamp Device	-20	Solid Nikaloy Cover																																																																																																						
-LF	Less Flange	-24	Chained Grate																																																																																																						
-LG	Less Grate	-31	Sediment Bucket (Aluminum)																																																																																																						
-HG	Hinged Grate (-NB Only)	-32	Shallow Sediment Bucket (Aluminum)																																																																																																						
-NB	Nickel Bronze Traffic Top	-33	Sediment Bucket (A.R. Finish)																																																																																																						
-TGI	Trap Guard Insert	-35	Stainless Steel Mesh Bucket Liner																																																																																																						
-VP	Secured Grate, Vandal-Proof Screws	-43	Internal Dome Strainer (A.R. Finish)																																																																																																						
-3	1/2 Grate	-45	Less Internal Dome Strainer																																																																																																						
-4	3/4 Grate	-51	Galvanized Cast Iron Inside and Outside																																																																																																						
-5	Nikaloy Extra Heavy-Duty Grate & Rim (Not SUPER-FLO® Design)	-52	Painted Inside and Outside																																																																																																						
-7	Full Grate with 2-1/2" Center Opening	-55	1/2" Primer Tap or Adapter																																																																																																						
-8	Stainless Steel Depressed Grate																																																																																																								
-15	Stainless Steel Rim and Grate	<b>Outlets</b>																																																																																																							
-16	Grate with 4" Round Funnel	-X	Inside Caulk Outlet																																																																																																						
-17	Grate with 6" Round Funnel	-Y	Hub Outlet w/Gasket 2" - 4"																																																																																																						
-18	Grate with 9" x 3-1/2" Oval Funnel	-Z	No-Hub Outlet																																																																																																						

	<b>12" SQUARE TOP, 8" DEEP</b>			
	LIST PRICE			
	PIPE SIZE	49340A	49340A -LF	49340A -NB
2" - 4"	\$2,581.00	\$2,198.00	\$3,328.00	\$2,945.00
ADD FOR OPTIONS:				
-3.....	\$0.00	-35* .....	\$464.00	
-4.....	0.00	-43.....	Deduct 334.00	
-5.....	1,078.00	-45.....	Deduct 59.00	
-7.....	176.00	-55** .....	187.00	
-8.....	187.00	-C .....	185.00	
-15.....	3,469.00	-HG.....	349.00	
-16 (ARE).....	375.00	-LF .....	Deduct 381.00	
-16 (NB) .....	420.00	-LG (ARE) .....	Deduct 224.00	
-17 (ARE).....	483.00	-LG (NB) .....	Deduct 487.00	
-17 (NB) .....	620.00	-NB.....	747.00	
-18 (ARE).....	523.00	-TGI .....	POA	
-18 (NB) .....	871.00	-VP (NB) .....	75.00	
-20 (NB) .....	223.00	-X .....	0.00	
-24 (NB) .....	212.00	-Y .....	0.00	
-31.....	310.00	-Z.....	0.00	
-33.....	595.00			
* Specify -31 or -33 Bucket ** 88450 Provided				

	<b>49420</b>				<b>SUPER-FLO® 16" SQUARE TOP, 12" DEEP</b>			
	LIST PRICE							
	PIPE SIZE	49420	49420 -LF	49420 -NB	49420 -LF-NB			
3", 4", 6"	\$4,651.00	\$4,156.00	\$5,859.00	\$5,364.00				
ADD FOR OPTIONS:								
-3.....	\$0.00	-43.....	\$310.00					
-4.....	0.00	-45.....	Deduct 59.00					
-7.....	176.00	-55** .....	187.00					
-16 (ARE).....	375.00	-C .....	556.00					
-16 (NB) .....	420.00	-LF .....	Deduct 495.00					
-17 (ARE).....	483.00	-LG (ARE) .....	Deduct 371.00					
-17 (NB) .....	620.00	-LG (NB) .....	Deduct 1,030.00					
-18 (ARE).....	523.00	-NB.....	1,208.00					
-18 (NB) .....	870.00	-TGI† .....	POA					
-31.....	823.00	-VP (NB) .....	75.00					
-33.....	2,314.00	-X .....	0.00					
-35* .....	931.00							
* Specify -31 or -33 Bucket ** 88450 Provided for 3" & 4". Body Primer Tapped for 6". † Available up to 4" only								

	<b>49360A</b>				<b>12" SQUARE TOP, 10" DEEP</b>			
	LIST PRICE							
	PIPE SIZE	49360A	49360A -LF	49360A -NB	49360A -LF-NB			
2" - 4"	\$2,708.00	\$2,329.00	\$3,455.00	\$3,076.00				
ADD FOR OPTIONS:								
-3.....	\$0.00	-33.....	\$595.00					
-4.....	0.00	-35* .....	464.00					
-5.....	1,078.00	-43.....	334.00					
-7.....	176.00	-45.....	Deduct 59.00					
-8.....	187.00	-55** .....	187.00					
-15.....	3,469.00	-C .....	185.00					
-16 (ARE).....	375.00	-HG.....	349.00					
-16 (NB) .....	420.00	-LF .....	Deduct 379.00					
-17 (ARE).....	483.00	-LG (ARE) .....	Deduct 224.00					
-17 (NB) .....	620.00	-LG (NB) .....	Deduct 487.00					
-18 (ARE).....	523.00	-NB.....	747.00					
-18 (NB) .....	871.00	-TGI .....	POA					
-20 (NB) .....	223.00	-VP (NB) .....	75.00					
-24 (NB) .....	212.00	-X .....	0.00					
-31.....	310.00	-Y .....	0.00					
-32.....	310.00	-Z.....	0.00					
* Specify -31 or -33 Bucket ** 88450 Provided								

	<b>49500</b>				<b>SUPER-FLO® 8" ROUND TOP, 3" DEEP</b>			
	LIST PRICE							
	PIPE SIZE	49500	49500 -LF	49500 -NB	49500 -LF-NB			
2" - 4"	\$1,546.00	\$1,263.00	\$1,790.00	\$1,506.00				
ADD FOR OPTIONS:								
-3.....	\$0.00	-43.....	\$310.00					
-4.....	0.00	-45.....	Deduct 59.00					
-7.....	176.00	-51.....	0.00					
-8.....	185.00	-52.....	Deduct 176.00					
-16 (ARE).....	375.00	-55** .....	187.00					
-16 (NB) .....	420.00	-C .....	185.00					
-17 (ARE).....	483.00	-LF .....	Deduct 283.00					
-17 (NB) .....	620.00	-LG (ARE) .....	Deduct 187.00					
-18 (ARE).....	523.00	-LG (NB) .....	Deduct 205.00					
-18 (NB) .....	870.00	-NB.....	243.00					
-31.....	223.00	-TGI .....	POA					
-33.....	536.00	-X .....	0.00					
-35* .....	464.00	-VP (NB) .....	75.00					
* Specify -31 or -33 Bucket ** 88450 Provided								

	<b>49400</b>				<b>SUPER-FLO® 16" SQUARE TOP, 6" DEEP</b>			
	LIST PRICE							
	PIPE SIZE	49400	49400 -LF	49400 -NB	49400 -LF-NB			
3", 4", 6"	\$4,651.00	\$4,285.00	\$5,859.00	\$5,493.00				
ADD FOR OPTIONS:								
-3.....	\$0.00	-43.....	\$310.00					
-4.....	0.00	-45.....	Deduct 59.00					
-7.....	176.00	-55** .....	187.00					
-16 (ARE).....	375.00	-C .....	556.00					
-16 (NB) .....	420.00	-LF .....	Deduct 366.00					
-17 (ARE).....	483.00	-LG (ARE) .....	Deduct 371.00					
-17 (NB) .....	620.00	-LG (NB) .....	Deduct 1,030.00					
-18 (ARE).....	523.00	-NB.....	1,208.00					
-18 (NB) .....	870.00	-TGI† .....	POA					
-31.....	823.00	-VP (NB) .....	75.00					
-33.....	2,314.00	-X .....	0.00					
-35* .....	931.00							
* Specify -31 or -33 Bucket ** 88450 Provided for 3" & 4". Body Primer Tapped for 6". † Available up to 4" only								

	<b>49520A</b>				<b>SUPER-FLO® 8" ROUND TOP, 6" DEEP</b>			
	LIST PRICE							
	PIPE SIZE	49520A	49520A -LF	49520A -NB	49520A -LF-NB			
2" - 4"	\$1,591.00	\$1,309.00	\$2,041.00	\$1,758.00				
ADD FOR OPTIONS:								
-3.....	\$0.00	-45.....	Deduct 59.00					
-4.....	0.00	-51.....	0.00					
-7.....	176.00	-52.....	Deduct 164.00					
-8.....	185.00	-55** .....	187.00					
-16 (ARE).....	375.00	-C .....	185.00					
-16 (NB) .....	420.00	-LF .....	Deduct 282.00					
-17 (ARE).....	483.00	-LG (ARE) .....	Deduct 187.00					
-17 (NB) .....	620.00	-LG (NB) .....	Deduct 205.00					
-18 (ARE).....	523.00	-NB.....	450.00					
-18 (NB) .....	870.00	-TGI .....	POA					
-31.....	223.00	-VP (NB) .....	75.00					
-33.....	536.00	-X .....	0.00					
-35* .....	464.00	-Z .....	0.00					
-43.....	310.00							
* Specify -31 or -33 Bucket ** 88450 Provided								

	<b>SUPER-FLO® 12" ROUND TOP, 8" DEEP</b>				
	LIST PRICE				
PIPE SIZE	49580A	49580A -LF	49580A -NB	49580A -LF-NB	
2" - 4"	\$2,034.00	\$1,663.00	\$3,024.00	\$2,653.00	
<b>ADD FOR OPTIONS:</b>					
-3.....	\$0.00	-45.....	Deduct \$59.00		
-4.....	0.00	-51.....	0.00		
-7.....	176.00	-52.....	Deduct 283.00		
-8.....	187.00	-55**.....	187.00		
-16 (ARE).....	375.00	-C.....	185.00		
-16 (NB).....	420.00	-LF.....	Deduct 371.00		
-17 (ARE).....	483.00	-LG (ARE).....	Deduct 259.00		
-17 (NB).....	620.00	-LG (NB).....	Deduct 504.00		
-18 (ARE).....	523.00	-NB.....	990.00		
-18 (NB).....	870.00	-TGI.....	POA		
-31.....	310.00	-VP (NB).....	75.00		
-33.....	536.00	-X.....	0.00		
-35*.....	464.00	-Z.....	0.00		
-43.....	310.00				
* Specify -31 or -33 Bucket ** 88450 Provided					

	<b>12" ROUND FLUSHING RIM TOP</b>		
	LIST PRICE		
PIPE SIZE	49850		
2", 3",* 4", 6"	\$2,585.00 2,585.00		
<b>ADD FOR OPTIONS:</b>			
-13.....	\$97.00	-C.....	\$187.00
-14.....	284.00	-TGI†.....	POA
-51.....	0.00	-VP.....	0.00
-98.....	5,546.00	-X.....	0.00
		-Z (6").....	0.00
*The 49852 and 49853 use a 49854 Body with a Reducing Coupling. † Available up to 4" only			

	<b>4" X 8" RECTANGULAR TOP, 4" DEEP</b>				
	LIST PRICE				
PIPE SIZE	49700	49700 -LF	49700 -NB	49700 -LF-NB	
2", 3"	\$1,802.00	\$1,615.00	\$2,125.00	\$1,938.00	
<b>ADD FOR OPTIONS:</b>					
-3.....	\$0.00	-52.....	Deduct \$164.00		
-4.....	0.00	-55*.....	187.00		
-7.....	176.00	-C.....	185.00		
-8.....	187.00	-LF.....	Deduct 187.00		
-16 (ARE).....	375.00	-LG (ARE).....	Deduct 147.00		
-16 (NB).....	420.00	-LG (NB).....	Deduct 297.00		
-30.....	464.00	-NB.....	323.00		
-43.....	310.00	-TGI.....	POA		
-45.....	Deduct 59.00	-VP (NB).....	75.00		
-51.....	0.00	-X.....	0.00		
* 88450 Provided					

	<b>12" SQUARE CAN WASH DRAIN</b>		
	LIST PRICE		
PIPE SIZE	49870A		
3", 4"	\$5,028.00		
<b>ADD FOR OPTIONS:</b>			
-35.....	\$290.00	-C.....	\$185.00
-51.....	0.00	-TGI.....	POA
-55*.....	187.00	-VP.....	75.00
-98.....	5,546.00	-X.....	0.00
		-Z.....	0.00
* 88450 Provided			

	<b>6" X 12" RECTANGULAR TOP, 7" DEEP</b>				
	LIST PRICE				
PIPE SIZE	49720	49720 -LF	49720 -NB	49720 -LF-NB	
3", 4", 6"	\$2,398.00	\$2,125.00	\$2,881.00	\$2,608.00	
<b>ADD FOR OPTIONS:</b>					
-LF.....	Deduct \$273.00	-16 (NB).....	\$420.00		
-NB.....	483.00	-18 (ARE).....	523.00		
-LG (ARE).....	Deduct 187.00	-18 (NB).....	867.00		
-LG (NB).....	Deduct 334.00	-30.....	464.00		
-3.....	0.00	-43.....	310.00		
-4.....	0.00	-45.....	Deduct 59.00		
-7.....	176.00	-51.....	0.00		
-8.....	187.00	-52.....	Deduct 282.00		
-TGI†.....	POA	-55*.....	187.00		
-VP (NB).....	75.00	-C.....	185.00		
-16 (ARE).....	375.00	-X.....	0.00		
* 88450 Provided for 3" & 4". Body Primer Tapped for 6". † Available up to 4" only					

### OPTION DESCRIPTIONS

- C Clamp Device
- LF Less Flange
- LG Less Grate
- NB Nickel Bronze Traffic Top
- TGI Trap Guard Insert
- VP Secured Grate, Vandal-Proof Screws
- 3 1/2 Grate
- 4 3/4 Grate
- 7 Full Grate with 2-1/2" Center Opening
- 8 Stainless Steel Depressed Grate
- 13 One-Piece Satin Nikaloy Grate
- 14 Loose-Set Satin Nikaloy Grate
- 16 Grate with 4" Round Funnel
- 17 Grate with 6" Round Funnel
- 18 Grate with 9" x 3-1/2" Oval Funnel
- 30 Stainless Steel Sediment Bucket
- 31 Sediment Bucket (Aluminum)
- 33 Sediment Bucket (A.R. Finish)
- 35 Stainless Steel Mesh Bucket Liner
- 43 Internal Dome Strainer (A.R. Finish)
- 45 Less Internal Dome Strainer
- 51 Galvanized Cast Iron Inside and Outside
- 52 Painted Inside and Outside
- 55 1/2" Primer Tap or Adapter
- 98 Water Supply Control Box

### Outlets

- X Inside Caulk Outlet
- Z No-Hub Outlet

	<b>LEVEZE® KLEENATRON® II SPECIAL-DUTY</b>																																																																		
	<b>LIST PRICE</b>																																																																		
	<b>PIPE SIZE</b>	<b>55000</b>	<b>55000-1 55000-2</b>	<b>55000-1-12 55000-2-12</b>	<b>55000-1-SQ 55000-2-SQ</b>	<b>55000-SS 55000-SS-SQ</b>	<b>55000-1-SD 55000-2-SD</b>	<b>55000-1-13 55000-2-13</b>																																																											
	2"	\$506.00	\$622.00	\$622.00	\$622.00	\$1,076.00	\$773.00	\$933.00																																																											
	3"	579.00	656.00	656.00	656.00	1,111.00	811.00	1,005.00																																																											
	4"	686.00	877.00	877.00	877.00	1,331.00	1,029.00	1,228.00																																																											
	5" (Z)	1,199.00	1,427.00	1,427.00	1,427.00	1,882.00	1,583.00	1,814.00																																																											
	6" (Z)	1,199.00	1,427.00	1,427.00	1,427.00	1,882.00	1,583.00	1,814.00																																																											
	<b>ADD FOR OPTIONS:</b>																																																																		
	<table border="0"> <tr> <td>-1 .....</td><td>ABOVE</td> <td>-5 .....</td><td>\$303.00</td> <td>-F .....</td><td>\$94.00</td> </tr> <tr> <td>-1-12 .....</td><td>ABOVE</td> <td>-14 .....</td><td>77.00</td> <td>-GC (CI Only) .....</td><td>301.00</td> </tr> <tr> <td>-1-13 .....</td><td>ABOVE</td> <td>-22 (2" - 4") .....</td><td>189.00</td> <td>-SS .....</td><td>ABOVE</td> </tr> <tr> <td>-1-SD .....</td><td>ABOVE</td> <td>-22 (5" - 6") .....</td><td>606.00</td> <td>-SS-SD .....</td><td>537.00</td> </tr> <tr> <td>-1-SQ .....</td><td>ABOVE</td> <td>-31 .....</td><td>217.00</td> <td>-SS-SQ .....</td><td>ABOVE</td> </tr> <tr> <td>-2 .....</td><td>ABOVE</td> <td>-41 .....</td><td>106.00</td> <td>-WF* .....</td><td>466.00</td> </tr> <tr> <td>-2-12 .....</td><td>ABOVE</td> <td>-ARE .....</td><td>349.00</td> <td>-X .....</td><td>0.00</td> </tr> <tr> <td>-2-13 .....</td><td>ABOVE</td> <td>-CFC .....</td><td>283.00</td> <td>-Y .....</td><td>0.00</td> </tr> <tr> <td>-2-SD .....</td><td>ABOVE</td> <td>-DBCL (4" X, 6" Z) .....</td><td>62.00</td> <td>-Z .....</td><td>0.00</td> </tr> <tr> <td>-2-SQ .....</td><td>ABOVE</td> <td>-DBCS .....</td><td>60.00</td> <td>-VP .....</td><td>94.00</td> </tr> </table>								-1 .....	ABOVE	-5 .....	\$303.00	-F .....	\$94.00	-1-12 .....	ABOVE	-14 .....	77.00	-GC (CI Only) .....	301.00	-1-13 .....	ABOVE	-22 (2" - 4") .....	189.00	-SS .....	ABOVE	-1-SD .....	ABOVE	-22 (5" - 6") .....	606.00	-SS-SD .....	537.00	-1-SQ .....	ABOVE	-31 .....	217.00	-SS-SQ .....	ABOVE	-2 .....	ABOVE	-41 .....	106.00	-WF* .....	466.00	-2-12 .....	ABOVE	-ARE .....	349.00	-X .....	0.00	-2-13 .....	ABOVE	-CFC .....	283.00	-Y .....	0.00	-2-SD .....	ABOVE	-DBCL (4" X, 6" Z) .....	62.00	-Z .....	0.00	-2-SQ .....	ABOVE	-DBCS .....	60.00	-VP .....
-1 .....	ABOVE	-5 .....	\$303.00	-F .....	\$94.00																																																														
-1-12 .....	ABOVE	-14 .....	77.00	-GC (CI Only) .....	301.00																																																														
-1-13 .....	ABOVE	-22 (2" - 4") .....	189.00	-SS .....	ABOVE																																																														
-1-SD .....	ABOVE	-22 (5" - 6") .....	606.00	-SS-SD .....	537.00																																																														
-1-SQ .....	ABOVE	-31 .....	217.00	-SS-SQ .....	ABOVE																																																														
-2 .....	ABOVE	-41 .....	106.00	-WF* .....	466.00																																																														
-2-12 .....	ABOVE	-ARE .....	349.00	-X .....	0.00																																																														
-2-13 .....	ABOVE	-CFC .....	283.00	-Y .....	0.00																																																														
-2-SD .....	ABOVE	-DBCL (4" X, 6" Z) .....	62.00	-Z .....	0.00																																																														
-2-SQ .....	ABOVE	-DBCS .....	60.00	-VP .....	94.00																																																														
* Not Available on Cast Iron																																																																			

	<b>SPANNER TYPE FLOOR CLEANOUT</b>																
	<b>LIST PRICE</b>																
	<b>PIPE SIZE</b>	<b>2"</b>	<b>3"</b>	<b>4"</b>	<b>5"</b>	<b>6"</b>											
		\$487.00	\$675.00	\$750.00	\$1,179.00	\$1,289.00											
<b>ADD FOR OPTIONS:</b>																	
<table border="0"> <tr> <td>-2 .....</td><td>Deduct \$75.00</td> <td>-24 .....</td><td>\$147.00</td> </tr> <tr> <td>-14 .....</td><td>77.00</td> <td>-ARE .....</td><td>349.00</td> </tr> <tr> <td></td><td></td> <td>-X .....</td><td>0.00</td> </tr> </table>						-2 .....	Deduct \$75.00	-24 .....	\$147.00	-14 .....	77.00	-ARE .....	349.00			-X .....	0.00
-2 .....	Deduct \$75.00	-24 .....	\$147.00														
-14 .....	77.00	-ARE .....	349.00														
		-X .....	0.00														

	<b>FLOOR CLEANOUT</b>																													
	<b>LIST PRICE</b>																													
	<b>PIPE SIZE</b>	<b>2", 3"</b>	<b>4"</b>																											
		\$971.00	\$1,008.00																											
<b>ADD FOR OPTIONS:</b>																														
<table border="0"> <tr> <td>-1 .....</td><td>\$396.00</td> <td>-20 .....</td><td>\$0.00</td> </tr> <tr> <td>-2 .....</td><td>343.00</td> <td>-31 .....</td><td>441.00</td> </tr> <tr> <td>-6 .....</td><td>319.00</td> <td>-ARE .....</td><td>349.00</td> </tr> <tr> <td>-6-1 .....</td><td>788.00</td> <td>-AE .....</td><td>235.00</td> </tr> <tr> <td>-6-2 .....</td><td>679.00</td> <td>-VP .....</td><td>147.00</td> </tr> <tr> <td>-12 .....</td><td>352.00</td> <td>-X .....</td><td>0.00</td> </tr> <tr> <td>-14 .....</td><td>77.00</td> <td></td><td></td> </tr> </table>			-1 .....	\$396.00	-20 .....	\$0.00	-2 .....	343.00	-31 .....	441.00	-6 .....	319.00	-ARE .....	349.00	-6-1 .....	788.00	-AE .....	235.00	-6-2 .....	679.00	-VP .....	147.00	-12 .....	352.00	-X .....	0.00	-14 .....	77.00		
-1 .....	\$396.00	-20 .....	\$0.00																											
-2 .....	343.00	-31 .....	441.00																											
-6 .....	319.00	-ARE .....	349.00																											
-6-1 .....	788.00	-AE .....	235.00																											
-6-2 .....	679.00	-VP .....	147.00																											
-12 .....	352.00	-X .....	0.00																											
-14 .....	77.00																													

	<b>LEVEZE® KLEENATRON® SPECIAL-DUTY CAST IRON TOP 57008-Z-CI Standard</b>																																	
	<b>LIST PRICE</b>																																	
	<b>PIPE SIZE</b>	<b>8"</b>	<b>\$1,399.00</b>																															
	<b>ADD FOR OPTIONS:</b>																																	
<table border="0"> <tr> <td>-1 .....</td><td>\$229.00</td> <td>-14 .....</td><td>\$77.00</td> </tr> <tr> <td>-1-12 .....</td><td>232.00</td> <td>-31 .....</td><td>212.00</td> </tr> <tr> <td>-1-SD .....</td><td>385.00</td> <td>-ARE .....</td><td>349.00</td> </tr> <tr> <td>-1-SQ .....</td><td>229.00</td> <td>-CFC .....</td><td>283.00</td> </tr> <tr> <td>-2 .....</td><td>171.00</td> <td>-DBC .....</td><td>107.00</td> </tr> <tr> <td>-2-12 .....</td><td>171.00</td> <td>-LT .....</td><td>Deduct 623.00</td> </tr> <tr> <td>-2-SD .....</td><td>328.00</td> <td>-VP .....</td><td>92.00</td> </tr> <tr> <td>-2-SQ .....</td><td>171.00</td> <td>-Z .....</td><td>STD</td> </tr> </table>			-1 .....	\$229.00	-14 .....	\$77.00	-1-12 .....	232.00	-31 .....	212.00	-1-SD .....	385.00	-ARE .....	349.00	-1-SQ .....	229.00	-CFC .....	283.00	-2 .....	171.00	-DBC .....	107.00	-2-12 .....	171.00	-LT .....	Deduct 623.00	-2-SD .....	328.00	-VP .....	92.00	-2-SQ .....	171.00	-Z .....	STD
-1 .....	\$229.00	-14 .....	\$77.00																															
-1-12 .....	232.00	-31 .....	212.00																															
-1-SD .....	385.00	-ARE .....	349.00																															
-1-SQ .....	229.00	-CFC .....	283.00																															
-2 .....	171.00	-DBC .....	107.00																															
-2-12 .....	171.00	-LT .....	Deduct 623.00																															
-2-SD .....	328.00	-VP .....	92.00																															
-2-SQ .....	171.00	-Z .....	STD																															

	<b>THREADED BRONZE PLUG</b>									
	<b>LIST PRICE</b>									
	<b>PIPE SIZE</b>	<b>1"</b>	<b>1-1/4"</b>	<b>1-1/2"</b>	<b>2"</b>	<b>2-1/2"</b>	<b>3"</b>			
		\$41.00	\$41.00	\$41.00	\$53.00	\$67.00	\$92.00			
<b>PIPE SIZE</b>	<b>3-1/2"</b>	<b>4"</b>	<b>5"</b>	<b>6"</b>	<b>8"</b>	<b>*10"</b>				
	\$153.00	\$172.00	\$256.00	\$352.00	\$711.00	\$1,048.00				
<b>ADD FOR OPTIONS:</b>										
<table border="0"> <tr> <td>-19 .....</td><td>\$45.00</td> <td>-20 .....</td><td>\$0.00</td> </tr> </table>							-19 .....	\$45.00	-20 .....	\$0.00
-19 .....	\$45.00	-20 .....	\$0.00							
* For 10" Size, Specify 58549-20. 10" Size Available with Raised Head Plug Only										

	<b>ACCESS HOUSING AND COVER</b>																											
	<b>LIST PRICE</b>																											
	<b>PIPE SIZE</b>	<b>58580</b>	<b>58580-1 58580-SQ</b>	<b>58580-2</b>	<b>58580-5</b>																							
	2"	\$299.00	\$411.00	\$374.00	\$598.00																							
3", 4"	418.00	582.00	530.00	717.00																								
5", 6"	552.00	735.00	695.00	850.00																								
<b>ADD FOR OPTIONS:</b>																												
<table border="0"> <tr> <td>-1 (2") .....</td><td>\$112.00</td> <td>-5 .....</td><td>\$299.00</td> </tr> <tr> <td>-1 (3", 4") .....</td><td>164.00</td> <td>-14 .....</td><td>77.00</td> </tr> <tr> <td>-1 (5", 6") .....</td><td>184.00</td> <td>-SD .....</td><td>156.00</td> </tr> <tr> <td>-2 (2") .....</td><td>75.00</td> <td>-SQ (2") .....</td><td>112.00</td> </tr> <tr> <td>-2 (3", 4") .....</td><td>112.00</td> <td>-SQ (3", 4") .....</td><td>164.00</td> </tr> <tr> <td>-2 (5", 6") .....</td><td>144.00</td> <td>-SQ (5", 6") .....</td><td>184.00</td> </tr> </table>					-1 (2") .....	\$112.00	-5 .....	\$299.00	-1 (3", 4") .....	164.00	-14 .....	77.00	-1 (5", 6") .....	184.00	-SD .....	156.00	-2 (2") .....	75.00	-SQ (2") .....	112.00	-2 (3", 4") .....	112.00	-SQ (3", 4") .....	164.00	-2 (5", 6") .....	144.00	-SQ (5", 6") .....	184.00
-1 (2") .....	\$112.00	-5 .....	\$299.00																									
-1 (3", 4") .....	164.00	-14 .....	77.00																									
-1 (5", 6") .....	184.00	-SD .....	156.00																									
-2 (2") .....	75.00	-SQ (2") .....	112.00																									
-2 (3", 4") .....	112.00	-SQ (3", 4") .....	164.00																									
-2 (5", 6") .....	144.00	-SQ (5", 6") .....	184.00																									

  

	<b>DEBRIS COVER</b>		
	<b>LIST PRICE</b>		
	<b>SERIES</b>	<b>COVER</b>	<b>ADD FOR OPTION:</b>
	55000	-DBCS	\$62.00
55004-X	-DBCL	62.00	
55006-Z	-DBCL	62.00	
57008	-DBC	107.00	

  

	<b>ADJUSTABLE FLOOR CLEANOUT</b>																				
	<b>LIST PRICE</b>																				
	<b>PIPE SIZE</b>	<b>2"</b>	<b>3"</b>	<b>4"</b>	<b>5"</b>	<b>6"</b>															
		\$491.00	\$562.00	\$645.00	\$726.00	\$740.00															
<b>ADD FOR OPTIONS:</b>																					
<table border="0"> <tr> <td>-2 .....</td><td>Deduct \$37.00</td> <td>-VP .....</td><td>\$92.00</td> </tr> <tr> <td>-31 .....</td><td>88.00</td> <td>-Y .....</td><td>0.00</td> </tr> <tr> <td>-14 .....</td><td>77.00</td> <td>-Z .....</td><td>0.00</td> </tr> <tr> <td>-ARE .....</td><td>349.00</td> <td></td><td></td> </tr> </table>						-2 .....	Deduct \$37.00	-VP .....	\$92.00	-31 .....	88.00	-Y .....	0.00	-14 .....	77.00	-Z .....	0.00	-ARE .....	349.00		
-2 .....	Deduct \$37.00	-VP .....	\$92.00																		
-31 .....	88.00	-Y .....	0.00																		
-14 .....	77.00	-Z .....	0.00																		
-ARE .....	349.00																				



	58600 WALL ACCESS COVER		
	LIST PRICE		
	TYPE NO.	58604	58606
		\$138.00	\$172.00
<b>ADD FOR OPTIONS:</b>			
-17 .....	\$18.00	-COT6 .....	\$1,243.00
-20* .....	0.00	-PLG1-1/2 .....	41.00
-31** .....	156.00	-PLG2 .....	53.00
-CO2 .....	92.00	-PLG2-1/2 .....	67.00
-CO3 .....	147.00	-PLG3 .....	92.00
-CO4 .....	204.00	-PLG3-1/2 .....	153.00
-CO6 .....	416.00	-PLG4 .....	172.00
-COT2 .....	224.00	-PLG5 .....	256.00
-COT3 .....	279.00	-PLG6 .....	352.00
-COT4 .....	440.00	-VP .....	68.00
* Specify -PLG, -CO or -COT. ** Specify -CO or -COT.			

	58640 WALL ACCESS COVER		
	LIST PRICE		
	TYPE NO.	58642	58644
		\$596.00	\$877.00
<b>ADD FOR OPTIONS:</b>			
-2 (58642) .....	Deduct \$79.00	-CO3 .....	\$147.00
-2 (58644) .....	Deduct 114.00	-CO4 .....	204.00
-2 (58646) .....	Deduct 124.00	-CO6 .....	416.00
-10 .....	0.00	-COT2 .....	224.00
-2-10 .....	0.00	-COT3 .....	279.00
-20* .....	0.00	-COT4 .....	440.00
-31* .....	156.00	-COT6 .....	1,243.00
-CO2 .....	92.00	-VP .....	92.00
* Specify -CO or -COT.			

	58610 WALL OR FLOOR ACCESS COVER		
	LIST PRICE		
	TYPE NO.	58614	58616
		\$352.00	\$605.00
<b>ADD FOR OPTIONS:</b>			
-2 (58614) .....	Deduct \$35.00	-CO3 .....	\$147.00
-2 (58616) .....	Deduct 108.00	-CO4 .....	204.00
-2 (58618) .....	Deduct 108.00	-CO6 .....	416.00
-10 .....	0.00	-COT2 .....	224.00
-14 .....	77.00	-COT3 .....	279.00
-20* .....	0.00	-COT4 .....	440.00
-31* .....	156.00	-COT6 .....	1,243.00
-CO2 .....	92.00	-VP .....	92.00
* Specify -CO or -COT.			

	58620 WALL OR FLOOR ACCESS COVER		
	LIST PRICE		
	TYPE NO.	58624	58626
		\$811.00	\$1,054.00
<b>ADD FOR OPTIONS:</b>			
-2 (58624) .....	Deduct \$55.00	-CO3 .....	\$147.00
-2 (58626) .....	Deduct 114.00	-CO4 .....	204.00
-10 .....	0.00	-CO6 .....	416.00
-14 .....	77.00	-COT2 .....	224.00
-20* .....	0.00	-COT3 .....	279.00
-31* .....	156.00	-COT4 .....	440.00
-VP .....	92.00	-COT6 .....	1,243.00
-CO2 .....	92.00		
* Specify -CO or -COT.			

	58630 WALL OR FLOOR ACCESS COVER		
	LIST PRICE		
	TYPE NO.	58631	58632
		\$787.00	\$1,159.00
<b>ADD FOR OPTIONS:</b>			
-2 (58631) .....	Deduct \$75.00	-CO6 .....	\$416.00
-2 (58632) .....	Deduct 124.00	-COT2 .....	224.00
-20* .....	0.00	-COT3 .....	279.00
-31* .....	156.00	-COT4 .....	440.00
-CO2 .....	92.00	-COT6 .....	1,243.00
-CO3 .....	147.00	-VP .....	92.00
-CO4 .....	204.00		
* Specify -CO or -COT.			

### OPTION DESCRIPTIONS

- AE Adjustable Extension
- ARE Acid-Resisting Epoxy
- CFC Carpet Cleanout Flange Cover
- CO2 No-Hub Cleanout, 2"
- CO3 No-Hub Cleanout, 3"
- CO4 No-Hub Cleanout, 4"
- CO6 No-Hub Cleanout, 6"
- COT2 No-Hub Cleanout Tee, 2"
- COT3 No-Hub Cleanout Tee, 3"
- COT4 No-Hub Cleanout Tee, 4"
- COT6 No-Hub Cleanout Tee, 6"
- DBC Debris Cover
- DBCS Debris Cover Small
- DBCL Debris Cover Large
- F Flange Only
- GC Gasket Cover
- LT Less Top
- SS Stainless Steel Top
- SS-SQ Square Top, Stainless Steel
- VP Secured Cover, Vandal-Proof Screws
- WF Wide Flange (not available on CI)
- 1 Satin Finish Nikaloy Top
- 1-SD Special Duty Satin Finish Nikaloy Top
- 1-SQ Square Top, Satin Finish Nikaloy
- 1-12 Cover Recessed for Tile, Satin Finish Nikaloy
- 1-13 Terrazzo Tile Cover, Satin Finish Nikaloy
- 2 Satin Finish Bronze Top
- 2-SD Special Duty Satin Finish Bronze Top
- 2-SQ Square Top, Satin Finish Bronze
- 2-10 Satin Finish Bronze Scoriated Cover
- 2-12 Cover Recessed for Tile, Satin Finish Bronze
- 2-13 Terrazzo Tile Cover, Satin Finish Bronze
- 5 Ductile Iron Top
- 6 Square Top, Cast Iron
- 6-1 Square Top, Nikaloy
- 6-2 Square Top, Bronze
- 10 Scoriated Cover
- 11 Smooth Top
- 12 Cover Recessed for Tile
- 14 Carpet Cleanout Marker
- 20 Raised Head Bronze Plug
- 22 Taper Thread Bronze Plug
- 24 Spanner Wrench
- 31 Galvanized Cast Iron Parts
- 41 Clamp Ring and Flange

### Outlets

- X Inside Caulk Outlet
- Y Hub Outlet w/Gasket 2" - 4"
- Z No-Hub Outlet

**58650**



**STAINLESS STEEL WALL ACCESS COVER**

LIST PRICE		
TYPE NO.	58656	
	\$877.00	

**ADD FOR OPTIONS:**

-20*	\$0.00	-COT2	\$224.00
-31*	156.00	-COT3	279.00
-CO2	92.00	-COT4	440.00
-CO3	147.00	-COT6	1,243.00
-CO4	204.00	-VP	92.00
-CO6	416.00		

\* Specify -CO or -COT.

**58680**



**ACCESS COVER**

LIST PRICE		
TYPE NO.	58680	
	\$1,378.00	

**ADD FOR OPTIONS:**

-1	\$607.00	-ARE	\$349.00
-2	542.00	-CO2	92.00
-5	457.00	-CO3	147.00
-20*	0.00	-CO4	204.00
-26	165.00	-CO6	416.00
-31	552.00	-VP	92.00

Special Wording on Cover, SAN. or STORM.  
Specify on Order.....\$146.00

\* Specify -CO

**58900**



**NO-HUB CLEANOUT FERRULE**

LIST PRICE				
PIPE SIZE	2"	3"	4"	6"
	\$92.00	\$147.00	\$204.00	\$416.00

**ADD FOR OPTIONS:**

-19	\$45.00	-31	\$156.00
-20	0.00	-Z	0.00

**58910**



**NO-HUB CLEANOUT TEE WITH PLUG**

LIST PRICE				
PIPE SIZE	2"	3"	4"	6"
	\$224.00	\$279.00	\$440.00	\$1,243.00

**ADD FOR OPTIONS:**

-19	\$45.00	-31	\$156.00
-20	0.00	-Z	0.00

**Cleanout  
OPTION DESCRIPTIONS**

- ARE Acid-Resisting Epoxy
  - CO2 No-Hub Cleanout, 2"
  - CO3 No-Hub Cleanout, 3"
  - CO4 No-Hub Cleanout, 4"
  - CO6 No-Hub Cleanout, 6"
  - COT2 No-Hub Cleanout Tee, 2"
  - COT3 No-Hub Cleanout Tee, 3"
  - COT4 No-Hub Cleanout Tee, 4"
  - COT6 No-Hub Cleanout Tee, 6"
  - PLG1-1/2 Bronze NPT Plug, 1-1/2"
  - PLG2 Bronze NPT Plug, 2"
  - PLG2-1/2 Bronze NPT Plug, 2-1/2"
  - PLG3 Bronze NPT Plug, 3"
  - PLG3-1/2 Bronze NPT Plug, 3-1/2"
  - PLG4 Bronze NPT Plug, 4"
  - PLG5 Bronze NPT Plug, 5"
  - PLG6 Bronze NPT Plug, 6"
  - SD Special-Duty Top, Nikaloy
  - SQ Square Top
  - VP Secured Cover, Vandal-Proof Screws
  - 1 Satin Finish Nikaloy Top
  - 2 Satin Finish Bronze Top
  - 5 Ductile Iron Top
  - 10 Scoriated Cover
  - 14 Carpet Cleanout Marker
  - 17 Center Screw Longer than Standard
  - 19 Plug Tapped for Center Screw
  - 20 Raised Head Bronze Plug
  - 26 Gasketed Cover
  - 31 Galvanized Cast Iron Parts
- Outlet**
- Z No-Hub Outlet

60100H 	MANUAL CLEANING, ON-FLOOR TYPE													
	TYPE NO.	PIPE SIZE	FLOW RATE GPM	GR. CAP. LBS.	LIST PRICE	FOR OPTIONS, ADD TO LIST PRICE								
						-40	-61	-ISI	-EXT 6"	Ea. Add'l Inch Ext.	-RT	-ET	-HD	-AC
60102H	2	7	14	\$3,461.00	N/A	N/A	\$1,959.00	N/A	N/A	\$7,286.00	\$8,403.00	\$6,105.00	\$1,351.00	
60103H	2	10	20	4,067.00	\$5,628.00	\$1,888.00	1,959.00	\$5,044.00	\$251.00	7,579.00	8,802.00	6,566.00	1,351.00	
60104H	2	15	30	6,021.00	6,827.00	1,888.00	1,959.00	5,114.00	282.00	8,130.00	9,590.00	7,060.00	1,351.00	
60105H	3	20	40	7,371.00	7,635.00	1,888.00	1,959.00	5,114.00	321.00	8,652.00	10,337.00	7,478.00	1,893.00	
60106H	3	25	50	8,281.00	8,825.00	2,107.00	2,011.00	5,114.00	359.00	8,835.00	10,687.00	7,889.00	1,893.00	
60107H	3	35	70	10,236.00	10,831.00	2,190.00	2,276.00	6,196.00	397.00	8,835.00	11,649.00	8,720.00	1,893.00	
60108H	3	50	100	13,554.00	15,060.00	2,487.00	3,401.00	6,701.00	464.00	9,792.00	12,268.00	9,137.00	1,893.00	
60109H	3	75	150	27,858.00	POA	3,946.00	3,667.00	6,964.00	510.00	12,166.00	13,313.00	9,749.00	2,649.00	
60110H	4	100	200	31,339.00	POA	4,410.00	4,015.00	7,893.00	581.00	19,346.00	20,493.00	13,000.00	2,649.00	
<b>ADD FOR OPTIONS</b>														
-40 ..... ABOVE      -ET ..... ABOVE      -ISI* ..... ABOVE														
-61 ..... ABOVE      -EXT ..... ABOVE      -RT ..... ABOVE														
-85 ..... \$151.00      -GRD* ..... POA •      -SS ..... POA •														
-AC ..... ABOVE      -HD ..... ABOVE														
* -GRD Available Only on 60104H through 60110H. -GRD and -ISI Cannot be Furnished Together on 2" Sizes.														
• PRICE ON APPLICATION														



60100-SA 	SEMI-AUTOMATIC						
	TYPE NO.	PIPE SIZE	FLOW RATE GPM	GREASE CAP. LBS.	LIST PRICE	FOR OPTIONS, ADD TO LIST PRICE	
						-RT	-ET
60102-SA	2	7	14	\$8,889.00	\$7,130.00	\$8,734.00	
60103-SA	2	10	20	10,486.00	8,282.00	9,924.00	
60104-SA	2	15	30	11,173.00	9,200.00	11,035.00	
60105-SA	2	20	40	13,732.00	9,351.00	11,422.00	
60106-SA	3*	25	50	16,656.00	9,528.00	11,869.00	
60107-SA	3*	35	70	17,093.00	10,183.00	12,731.00	
60108-SA	3*	50	100	19,511.00	10,276.00	13,166.00	
60109-SA	3*	75	150	22,530.00	13,380.00	14,210.00	
<b>ADD FOR OPTIONS</b>							
-62 ..... \$0.00      -66 ..... \$308.00      -85 ..... \$151.00							
-65 ..... 219.00      -67 ..... 435.00      -ET ..... ABOVE							
-RT ..... ABOVE							
* 3" Sizes Normally Furnished with 4" x 3" Reducing Bushings.							

### GREASE INTERCEPTOR OPTION DESCRIPTIONS

- |      |  |     |  |
|------|--|-----|--|
| -ET  | Enclosed Type                                    | -SS | Stainless Steel                                    |
| -EXT | Extension, 6" Standard, Specify Extension Height | -40 | Cover Recess for Floor Finish                      |
| -GRD | Grease Removal Device                            | -61 | Flange and Clamp Device                            |
| -AC  | Aluminum Cover                                   | -62 | 4" Inlet and Outlet Available on Standard 3" Sizes |
| -HD  | Heavy-Duty Cover                                 | -65 | Hub Inlet, Spigot Outlet, 2"                       |
| -ISI | Integrated Solids Interceptor                    | -66 | Hub Inlet, Spigot Outlet, 3"                       |
| -RT  | Recessed Type                                    | -67 | Hub Inlet, Spigot Outlet, 4"                       |
|      |  | -85 | Enzymatic Port                                     |

# GREASE INTERCEPTORS



<b>60110A</b> 	MANUAL CLEANING, LOW TYPE					<b>60115A-SA</b> 	SEMI-AUTOMATIC, LOW TYPE				
	TYPE NO.	PIPE SIZE	FLOW RATE GPM	GREASE CAP. LBS.	LIST PRICE		TYPE NO.	PIPE SIZE	FLOW RATE GPM	GREASE CAP. LBS.	LIST PRICE
	60115A	2*	20	40	\$9,959.00		60115A	3	35	70	\$23,356.00
	60117A	3	35	70	12,825.00		-SA				
<b>ADD FOR OPTIONS:</b> -65 ..... \$219.00    -68 ..... \$0.00 -66 ..... 308.00    -85 ..... 151.00 *2" Sizes Normally Furnished with 3" x 2" Reducing Bushings					<b>ADD FOR OPTIONS:</b> -65 ..... \$219.00    -66 ..... \$295.00						

<b>60210A</b> 	MANUAL CLEANING TYPE, HIGH VOLUME										
	TYPE NO.	PIPE SIZE	FLOW RATE GPM	GREASE CAP. LBS.	LIST PRICE	FOR OPTIONS, ADD TO LIST PRICE					
						-EXT 6"	Ea. Add'l Inch Ext.	-60	-61	-ISI	-HD
	60213A	4	150	300	\$34,196.00	\$4,061.00	\$312.00	\$3,120.00	\$5,023.00	\$3,863.00	\$15,366.00
	60214A	5	200	400	49,608.00	7,312.00	329.00	3,342.00	5,869.00	4,060.00	17,523.00
	60215A	5	250	500	57,748.00	9,084.00	355.00	4,457.00	7,915.00	4,285.00	24,193.00
60216A	6	350	700	75,612.00	12,617.00	455.00	5,639.00	9,470.00	5,411.00	36,619.00	
60217A	6	500	1000	98,591.00	18,960.00	540.00	6,695.00	11,259.00	6,411.00	51,527.00	
<b>ADD FOR OPTIONS</b>											
-60 ..... ABOVE    -85 ..... 151.00    -HD ..... ABOVE -61 ..... ABOVE    -EXT ..... ABOVE    -ISI ..... ABOVE • PRICE ON APPLICATION											

60500B 	DRAW-OFF, GRAVITY TYPE								
	TYPE NO.	PIPE SIZE	FLOW RATE GPM	LIST PRICE	FOR OPTIONS, ADD TO LIST PRICE				
					-EXT 6"	Ea. Add'l Inch Ext.	-60•	-61•	-HD
60503B	2	10	\$5,559.00	\$5,205.00	\$229.00	\$1,419.00	\$1,705.00	\$5,919.00	
60504B	2	15	7,636.00	5,273.00	255.00	1,419.00	1,705.00	6,365.00	
60505B	3*	20	9,236.00	5,430.00	284.00	1,532.00	1,705.00	6,741.00	
60506B	3*	25	10,023.00	5,586.00	329.00	1,595.00	1,900.00	7,114.00	
60507B	3*	35	12,184.00	5,796.00	355.00	1,675.00	1,976.00	7,861.00	
60508B	3*	50	16,394.00	6,919.00	414.00	1,708.00	2,250.00	8,237.00	
* 3" Sizes Normally Furnished with 4" x 3" Reducing Bushings.									
ADD FOR OPTIONS									
-60• ..... ABOVE    -EXT ..... ABOVE    -HD ..... ABOVE									
-61• ..... ABOVE									
• Only Available with -EXT Option									

60500-EST 	DRAW-OFF, GRAVITY TYPE WITH EXTERNAL STORAGE TANK									
	TYPE NO.	PIPE SIZE	FLOW RATE GPM	TANK CAP. GAL.	LIST PRICE	FOR OPTIONS, ADD TO LIST PRICE				
						-EXT 6"	Ea. Add'l Inch Ext.	-60•	-61•	-HD
60503-EST-5	2	10	5	\$8,349.00	\$7,807.00	\$322.00	\$2,114.00	\$2,554.00	\$9,418.00	
60503-EST-50	2	10	50	11,799.00	8,978.00	372.00	2,428.00	2,933.00	10,831.00	
60504-EST-6	2	15	6	11,449.00	7,911.00	388.00	2,114.00	2,554.00	10,025.00	
60504-EST-50	2	15	50	12,450.00	9,104.00	443.00	2,428.00	2,933.00	11,532.00	
60505-EST-8	3*	20	8	13,855.00	8,152.00	440.00	2,114.00	2,554.00	10,612.00	
60505-EST-50	3*	20	50	15,336.00	9,376.00	507.00	2,428.00	2,933.00	12,201.00	
60506-EST-50	3*	25	50	15,027.00	8,225.00	482.00	2,397.00	2,794.00	10,998.00	
60506-EST-100	3*	25	100	16,722.00	8,633.00	493.00	2,397.00	2,794.00	12,098.00	
60507-EST-50	3*	35	50	18,270.00	8,518.00	523.00	2,449.00	2,889.00	11,574.00	
60507-EST-100	3*	35	100	19,966.00	8,949.00	534.00	2,449.00	2,889.00	12,725.00	
60508-EST-50	3*	50	50	20,705.00	9,722.00	595.00	2,490.00	3,307.00	11,062.00	
60508-EST-100	3*	50	100	24,152.00	10,151.00	607.00	2,490.00	3,307.00	12,159.00	
* 3" Sizes Normally Furnished with 4" x 3" Reducing Bushings.										
ADD FOR OPTIONS										
-19 ..... \$2,302.00    -61• ..... ABOVE    -HD ..... ABOVE										
-60• ..... ABOVE    -EXT ..... ABOVE										
• Only Available with -EXT Option										

60610A 	DRAW-OFF TYPE, HIGH VOLUME								
	TYPE NO.	PIPE SIZE	FLOW RATE GPM	LIST PRICE	FOR OPTIONS, ADD TO LIST PRICE				
					-EXT 6"	Ea. Add'l Inch Ext.	-60•	-61•	-HD
60611A	3	75	\$28,401.00	\$3,900.00	\$255.00	\$1,692.00	\$3,374.00	\$8,699.00	
60612A	4	100	30,800.00	4,061.00	272.00	2,081.00	3,775.00	11,960.00	
60613A	4	150	38,135.00	4,390.00	312.00	2,905.00	4,681.00	15,366.00	
60614A	5	200	53,877.00	6,277.00	329.00	3,115.00	5,466.00	17,523.00	
60615A	5	250	62,396.00	8,163.00	355.00	4,164.00	7,088.00	24,193.00	
60616A	6	350	78,859.00	11,754.00	455.00	5,247.00	8,811.00	36,619.00	
60617A	6	500	114,567.00	18,304.00	540.00	6,228.00	10,486.00	51,527.00	
ADD FOR OPTIONS									
-60• ..... ABOVE    -HD ..... ABOVE    -EXT ..... ABOVE									
-61• ..... ABOVE									
• Only Available with -EXT Option									

### OIL SEPARATOR OPTION DESCRIPTIONS

- |      |  |     |                         |
|------|--|-----|-------------------------|
| -EXT | Extension, 6" Standard, Specify Extension Height | -60 | Anchor Flange           |
| -HD  | Heavy-Duty Cover                                 | -61 | Flange and Clamp Device |
| -19  | Reclaim Tank Alarm                               |     |                         |

 EXTERNAL STORAGE TANK NOT SHOWN	DRAW-OFF, GRAVITY TYPE WITH EXTERNAL STORAGE TANK									
	TYPE NO.	PIPE SIZE	FLOW RATE GPM	TANK CAP. GAL	LIST PRICE	FOR OPTIONS, ADD TO LIST PRICE				
						-EXT 6"	Ea. Add'l Inch Ext.	-60•	-61•	-HD
	60611-EST	3	75	100	\$41,837.00	\$5,734.00	\$388.00	\$2,752.00	\$4,982.00	\$12,786.00
	60612-EST	4	100	250	46,212.00	6,091.00	414.00	3,149.00	5,651.00	17,958.00
	60613-EST	4	150	250	57,200.00	6,573.00	471.00	4,354.00	7,011.00	23,043.00
	60614-EST	5	200	250	75,743.00	8,843.00	471.00	4,657.00	8,193.00	24,675.00
	60615-EST	5	250	500	87,735.00	11,470.00	513.00	5,839.00	9,941.00	33,905.00
	60616-EST	6	350	500	110,904.00	16,534.00	638.00	7,367.00	12,368.00	49,016.00
	60617-EST	6	500	500	152,992.00	24,593.00	752.00	8,769.00	14,733.00	72,414.00
<b>ADD FOR OPTIONS</b>										
-19 ..... \$2,302.00    -61• ..... ABOVE    -HD ..... ABOVE -60• ..... ABOVE    -EXT ..... ABOVE										
• Only Available with -EXT Option										

	OIL SEDIMENT INTERCEPTOR		
	TYPE NO.	PIPE SIZE	LIST PRICE
	60816	2	\$3,659.00
	60817	4	9,869.00
	60818	4	14,033.00
60819	4	20,796.00	

	SOLIDS INTERCEPTOR TOP ACCESS ON-FLOOR TRAP TYPE		
	TYPE NO.	PIPE SIZE	LIST PRICE
	61042A	2	\$4,939.00
	61043A	3	4,939.00
	61044A	4	4,939.00
<b>ADD FOR OPTIONS:</b>			
-15 ..... \$1,217.00    -EXT* ..... \$839.00			
-16 ..... 793.00			
* 6" Standard, Each Add'l. Inch..... \$92.00			

	SOLIDS INTERCEPTOR BOTTOM ACCESS FIXTURE TRAP TYPE			
	TYPE NO.	INLET	OUTLET	LIST PRICE
	61001-1/4	1-1/4	1-1/2	\$1,718.00
	61001-1/2	1-1/2	1-1/2	1,718.00
	<b>ADD FOR OPTIONS:</b>			
-1 ..... Deduct \$778.00    -30 ..... Deduct \$227.00				
-3 ..... 0.00    -CP ..... POA•				
• PRICE ON APPLICATION				

	SOLIDS INTERCEPTOR TOP ACCESS IN-LINE TYPE		
	TYPE NO.	PIPE SIZE	LIST PRICE
	61072	2	\$3,081.00
	61073	3	5,100.00
	61074	4	7,109.00
<b>ADD FOR OPTIONS:</b>			
-4 ..... \$1,219.00    -86 ..... \$0.00			
-15 ..... 1,511.00			

	SOLIDS INTERCEPTOR CAST IRON TOP ACCESS FIXTURE TRAP TYPE		
	TYPE NO.	PIPE SIZE	LIST PRICE
	61031-1/2-1	1-1/2	\$1,276.00
	61032-1	2	1,276.00
	<b>ADD FOR OPTIONS:</b>		
-26 ..... \$707.00    -30 ..... \$364.00			

	SOLIDS INTERCEPTOR TOP ACCESS IN-LINE TYPE		
	TYPE NO.	PIPE SIZE	LIST PRICE
	61084	4	\$12,059.00
	61085	5	12,059.00
	61086	6	12,059.00
<b>ADD FOR OPTIONS:</b>			
-4 ..... \$2,697.00    -86 ..... \$0.00			
-15 ..... 1,975.00			

OIL & SOLIDS INTERCEPTOR OPTION DESCRIPTIONS			
-EXT	Extension, 6" Standard, Specify Extension Height	-16	Monel Screens
-HD	Heavy-Duty Cover	-19	Reclaim Tank Alarm
-CP	Chrome Plated Bronze	-26	Cast Aluminum
-1	Painted Cast Iron	-30	Acid-Resisting Cast Iron Inside and Outside
-3	Polished Bronze	-60	Anchor Flange
-4	Galvanized Cast Iron Parts	-61	Flange and Clamp Device
-15	Stainless Steel Basket	-86	Flat Bottom Basket

	SAND INTERCEPTOR					
	TYPE NO.	CAPACITY CUBIC FT.	SIZE GALLONS	LIST PRICE	FOR OPTIONS, ADD TO LIST PRICE	
					-EXT UP TO 6"	-HD
	61091	45	340	\$41,977.00	\$1,275.00	\$1,638.00
	61092	54	400	61,919.00	1,566.00	2,058.00
	61093	72	540	POA●	POA●	POA●
	61094	81	610	POA●	POA●	POA●
	61095	90	670	POA●	POA●	POA●
61096	108	810	POA●	POA●	POA●	
61097	135	1,010	POA●	POA●	POA●	
ADD FOR OPTIONS						
-EXT..... ABOVE      -HD..... ABOVE						
● PRICE ON APPLICATION						

	SAND/SEDIMENT INTERCEPTOR								
	TYPE NO.	PIPE SIZE	FLOW RATE GPM	NUMBER OF GRATES	LIST PRICE	FOR OPTIONS, ADD TO LIST PRICE			
						-EXT 6"	Ea. Add'l Inch Ext.	-HD	-61
	61103	4	20	2	\$13,110.00	\$805.00	\$90.00	\$2,519.00	\$2,190.00
	61104	4	50	4	22,229.00	1,249.00	132.00	5,037.00	3,946.00
	61105	4	150	8	67,175.00	2,232.00	230.00	10,078.00	5,869.00
	61106	6	250	12	93,298.00	3,358.00	342.00	18,190.00	9,470.00
	61107	8	500	20	125,025.00	5,691.00	576.00	25,186.00	11,259.00
ADD FOR OPTIONS									
-61..... ABOVE      -EXT..... ABOVE      -HD..... ABOVE									

	RICE INTERCEPTOR		
	TYPE NO.	PIPE SIZE	LIST PRICE
	61202	3	POA●
	61203	4	POA●
	61204	4	POA●
	61205	4	POA●
	61207	6	POA●
ADD FOR OPTIONS:			
-SS..... POA●      -T..... NC			
● PRICE ON APPLICATION			

	SOLIDS INTERCEPTOR IN-LINE TYPE			
	TYPE NO.	PIPE SIZE	FLOW RATE GPM	LIST PRICE
	61303	3	50	POA●
	61304	4	100	POA●
	ADD FOR OPTIONS:			
-CS..... POA●				
● PRICE ON APPLICATION				









	SOLIDS INTERCEPTOR DRAWER TYPE, SIDE INLET		
	TYPE NO.	PIPE SIZE	LIST PRICE
	61402	2	\$8,226.00
	ADD FOR OPTIONS:		
	-316..... \$1,645.00      -T..... POA●		
● PRICE ON APPLICATION			

	SOLIDS INTERCEPTOR DRAWER TYPE, TOP INLET		
	TYPE NO.	PIPE SIZE	LIST PRICE
	61502	2	\$8,226.00
	ADD FOR OPTIONS:		
	-316..... \$1,645.00      -T..... POA●		
● PRICE ON APPLICATION			

	LINT INTERCEPTOR						
	TYPE NO.	PIPE SIZE	FLOW RATE GPM	MAX. NUMBER OF WASHERS	LIST PRICE	FOR OPTIONS, ADD TO LIST PRICE	
						-EXT 6"	Ea. Add'l Inch Ext.
	61805	3	70	7	\$12,782.00	\$4,611.00	\$288.00
	61806	4	200	20	18,198.00	4,611.00	325.00
	61807	6	300	30	21,159.00	5,586.00	358.00
61808	6	400	40	24,127.00	6,041.00	418.00	

### SOLIDS INTERCEPTOR OPTION DESCRIPTIONS

- |      |   |      |  |
|------|---|------|--|
| -316 | Type 316 L Stainless Steel              | -EXT | Extension, 6" Standard, Specify Extension Height |
| -61  | Flange and Clamp Device                 | -HD  | Heavy-Duty Cover                                 |
| -CS  | Fabricated Steel Acid-Resisting Coating | -SS  | Stainless Steel                                  |
|      |   | -T   | NPT Threaded Connections                         |

<p><b>67100A</b></p> 	<p align="center"><b>BALL-FLOAT ADAPTER TYPE</b></p> <table border="1"> <thead> <tr> <th colspan="3">LIST PRICE</th> </tr> <tr> <th>PIPE SIZE</th> <th>2", 3", 4"</th> <th>6"</th> </tr> </thead> <tbody> <tr> <td></td> <td>\$575.00</td> <td>\$1,194.00</td> </tr> </tbody> </table> <p><b>ADD FOR OPTIONS:</b></p> <table> <tr> <td>-5 (2" - 4").....</td> <td>\$92.00</td> <td>-35 .....</td> <td>\$153.00</td> </tr> <tr> <td>-5 (6").....</td> <td>235.00</td> <td></td> <td></td> </tr> </table>	LIST PRICE			PIPE SIZE	2", 3", 4"	6"		\$575.00	\$1,194.00	-5 (2" - 4").....	\$92.00	-35 .....	\$153.00	-5 (6").....	235.00			<p><b>67650</b></p> 	<p align="center"><b>COMBINED DRAIN/SWING-CHECK TYPE</b></p> <table border="1"> <thead> <tr> <th colspan="3">LIST PRICE</th> </tr> <tr> <th>PIPE SIZE</th> <th>3", 4"</th> <th>6"</th> </tr> </thead> <tbody> <tr> <td></td> <td>\$1,814.00</td> <td>\$2,730.00</td> </tr> </tbody> </table> <p><b>ADD FOR OPTIONS:</b></p> <table> <tr> <td>-1 (3", 4").....</td> <td>\$859.00</td> <td>-25 .....</td> <td>\$260.00</td> </tr> <tr> <td>-1 (6").....</td> <td>747.00</td> <td>-LBV (3", 4").....</td> <td>Ded. 383.00</td> </tr> <tr> <td>-2 (3", 4").....</td> <td>575.00</td> <td>-LBV (6").....</td> <td>Ded. 672.00</td> </tr> <tr> <td>-2 (6").....</td> <td>475.00</td> <td>-VP .....</td> <td>143.00</td> </tr> <tr> <td>-5 .....</td> <td>575.00</td> <td></td> <td></td> </tr> </table>	LIST PRICE			PIPE SIZE	3", 4"	6"		\$1,814.00	\$2,730.00	-1 (3", 4").....	\$859.00	-25 .....	\$260.00	-1 (6").....	747.00	-LBV (3", 4").....	Ded. 383.00	-2 (3", 4").....	575.00	-LBV (6").....	Ded. 672.00	-2 (6").....	475.00	-VP .....	143.00	-5 .....	575.00		
LIST PRICE																																																	
PIPE SIZE	2", 3", 4"	6"																																															
	\$575.00	\$1,194.00																																															
-5 (2" - 4").....	\$92.00	-35 .....	\$153.00																																														
-5 (6").....	235.00																																																
LIST PRICE																																																	
PIPE SIZE	3", 4"	6"																																															
	\$1,814.00	\$2,730.00																																															
-1 (3", 4").....	\$859.00	-25 .....	\$260.00																																														
-1 (6").....	747.00	-LBV (3", 4").....	Ded. 383.00																																														
-2 (3", 4").....	575.00	-LBV (6").....	Ded. 672.00																																														
-2 (6").....	475.00	-VP .....	143.00																																														
-5 .....	575.00																																																
<p><b>67360</b></p> 	<p align="center"><b>SHEAR-GATE &amp; SWING-CHECK TYPE</b></p> <table border="1"> <thead> <tr> <th colspan="3">LIST PRICE</th> </tr> <tr> <th>PIPE SIZE</th> <th>67360</th> <th>67360-DH</th> </tr> </thead> <tbody> <tr> <td>3", 4"</td> <td>\$4,981.00</td> <td>\$4,981.00</td> </tr> <tr> <td>5", 6"</td> <td>7,333.00</td> <td>7,333.00</td> </tr> </tbody> </table> <p><b>ADD FOR OPTIONS:</b></p> <table> <tr> <td>-15 .....</td> <td>\$0.00</td> <td>-29 (3", 4").....</td> <td>\$2,872.00</td> </tr> <tr> <td>-28 (3", 4").....</td> <td>2,053.00</td> <td>-29 (5", 6").....</td> <td>3,144.00</td> </tr> <tr> <td>-28 (5", 6").....</td> <td>2,354.00</td> <td>-DH.....</td> <td>0.00</td> </tr> </table>	LIST PRICE			PIPE SIZE	67360	67360-DH	3", 4"	\$4,981.00	\$4,981.00	5", 6"	7,333.00	7,333.00	-15 .....	\$0.00	-29 (3", 4").....	\$2,872.00	-28 (3", 4").....	2,053.00	-29 (5", 6").....	3,144.00	-28 (5", 6").....	2,354.00	-DH.....	0.00	<p><b>67720</b></p> 	<p align="center"><b>HUB INLET, SWING-CHECK TYPE</b></p> <table border="1"> <thead> <tr> <th colspan="3">LIST PRICE</th> </tr> <tr> <th>PIPE SIZE</th> <th>3"</th> <th>4"</th> </tr> </thead> <tbody> <tr> <td></td> <td>\$539.00</td> <td>\$783.00</td> </tr> </tbody> </table> <p><b>ADD FOR OPTIONS:</b></p> <table> <tr> <td>-15 .....</td> <td>\$0.00</td> <td></td> <td></td> </tr> </table>	LIST PRICE			PIPE SIZE	3"	4"		\$539.00	\$783.00	-15 .....	\$0.00											
LIST PRICE																																																	
PIPE SIZE	67360	67360-DH																																															
3", 4"	\$4,981.00	\$4,981.00																																															
5", 6"	7,333.00	7,333.00																																															
-15 .....	\$0.00	-29 (3", 4").....	\$2,872.00																																														
-28 (3", 4").....	2,053.00	-29 (5", 6").....	3,144.00																																														
-28 (5", 6").....	2,354.00	-DH.....	0.00																																														
LIST PRICE																																																	
PIPE SIZE	3"	4"																																															
	\$539.00	\$783.00																																															
-15 .....	\$0.00																																																
<p><b>67400</b></p> 	<p align="center"><b>NO-HUB SWING-CHECK TYPE</b></p> <table border="1"> <thead> <tr> <th colspan="5">LIST PRICE</th> </tr> <tr> <th>PIPE SIZE</th> <th>2"</th> <th>3"</th> <th>4"</th> <th>6"</th> </tr> </thead> <tbody> <tr> <td></td> <td>\$1,289.00</td> <td>\$2,019.00</td> <td>\$2,486.00</td> <td>\$3,177.00</td> </tr> </tbody> </table>	LIST PRICE					PIPE SIZE	2"	3"	4"	6"		\$1,289.00	\$2,019.00	\$2,486.00	\$3,177.00	<p><b>67800</b></p> 	<p align="center"><b>HUB INLET, SWING-CHECK TYPE</b></p> <table border="1"> <thead> <tr> <th colspan="3">LIST PRICE</th> </tr> <tr> <th>PIPE SIZE</th> <th>6"</th> <th>8"</th> </tr> </thead> <tbody> <tr> <td></td> <td>\$2,233.00</td> <td>\$2,718.00</td> </tr> </tbody> </table> <p><b>ADD FOR OPTIONS:</b></p> <table> <tr> <td>-4 .....</td> <td>\$787.00</td> <td>-15 .....</td> <td>\$0.00</td> </tr> </table>	LIST PRICE			PIPE SIZE	6"	8"		\$2,233.00	\$2,718.00	-4 .....	\$787.00	-15 .....	\$0.00																		
LIST PRICE																																																	
PIPE SIZE	2"	3"	4"	6"																																													
	\$1,289.00	\$2,019.00	\$2,486.00	\$3,177.00																																													
LIST PRICE																																																	
PIPE SIZE	6"	8"																																															
	\$2,233.00	\$2,718.00																																															
-4 .....	\$787.00	-15 .....	\$0.00																																														
<p><b>67500</b></p> 	<p align="center"><b>HUB &amp; SPIGOT SWING-CHECK TYPE</b></p> <table border="1"> <thead> <tr> <th colspan="4">LIST PRICE</th> </tr> <tr> <th>PIPE SIZE</th> <th>2"</th> <th>3"</th> <th>4"</th> </tr> </thead> <tbody> <tr> <td></td> <td>\$1,289.00</td> <td>\$2,019.00</td> <td>\$2,486.00</td> </tr> <tr> <th>PIPE SIZE</th> <th>6"</th> <th>8"</th> <th></th> </tr> <tr> <td></td> <td>\$3,571.00</td> <td>\$5,017.00</td> <td></td> </tr> </tbody> </table> <p><b>ADD FOR OPTIONS:</b></p> <table> <tr> <td>-5 (2" - 4").....</td> <td>\$521.00</td> <td>-15 .....</td> <td>\$0.00</td> </tr> <tr> <td>-5 (6" - 8").....</td> <td>1,305.00</td> <td>-30 .....</td> <td>403.00</td> </tr> <tr> <td>-10* .....</td> <td>0.00</td> <td></td> <td></td> </tr> </table> <p>* For Extension, Use -10 Option with Hub and Spigot Extension Pipe by Others.</p>	LIST PRICE				PIPE SIZE	2"	3"	4"		\$1,289.00	\$2,019.00	\$2,486.00	PIPE SIZE	6"	8"			\$3,571.00	\$5,017.00		-5 (2" - 4").....	\$521.00	-15 .....	\$0.00	-5 (6" - 8").....	1,305.00	-30 .....	403.00	-10* .....	0.00			<p><b>Backwater Valve OPTION DESCRIPTIONS</b></p> <ul style="list-style-type: none"> <li>-DH Double Hub</li> <li>-LBV Less Backwater Valve</li> <li>-VP Secured Face, Vandal-Proof Screws</li> <li>-1 Satin Finish Nikaloy Face</li> <li>-2 Satin Finish Bronze Face</li> <li>-4 Bronze Seat</li> <li>-5 Galvanized Cast Iron Parts</li> <li>-10 Threaded Bronze Cover</li> <li>-15 Open Flap</li> <li>-25 Flashing Clamp Device</li> <li>-28 12" Cast Iron Extension and Stem</li> <li>-29 24" Cast Iron Extension and Stem</li> <li>-30 2" Auxiliary Inlet with Bronze Plug</li> <li>-35 1/2" Primer Tap</li> </ul>															
LIST PRICE																																																	
PIPE SIZE	2"	3"	4"																																														
	\$1,289.00	\$2,019.00	\$2,486.00																																														
PIPE SIZE	6"	8"																																															
	\$3,571.00	\$5,017.00																																															
-5 (2" - 4").....	\$521.00	-15 .....	\$0.00																																														
-5 (6" - 8").....	1,305.00	-30 .....	403.00																																														
-10* .....	0.00																																																
<p><b>67600</b></p> 	<p align="center"><b>HUB &amp; SPIGOT SWING-CHECK TYPE</b></p> <table border="1"> <thead> <tr> <th colspan="3">LIST PRICE</th> </tr> <tr> <th>TYPE NO.</th> <th>PIPE SIZE</th> <th></th> </tr> </thead> <tbody> <tr> <td>67610</td> <td>10"</td> <td>\$8,195.00</td> </tr> <tr> <td>67612</td> <td>12"</td> <td>10,633.00</td> </tr> </tbody> </table> <p><b>ADD FOR OPTIONS:</b></p> <table> <tr> <td>-15 .....</td> <td>\$0.00</td> <td></td> <td></td> </tr> </table>	LIST PRICE			TYPE NO.	PIPE SIZE		67610	10"	\$8,195.00	67612	12"	10,633.00	-15 .....	\$0.00																																		
LIST PRICE																																																	
TYPE NO.	PIPE SIZE																																																
67610	10"	\$8,195.00																																															
67612	12"	10,633.00																																															
-15 .....	\$0.00																																																





**71300**

QUARTER-TURN HYDRANT, BOX TYPE FOR NSF/ANSI 61		
LIST PRICE		
SIZE		
6-1/4	71300-6-QTR	\$1,525.00
7-1/4	71300-7-QTR	1,525.00
9-1/4	71300-9-QTR	1,577.00
11-1/4	71300-11-QTR	1,577.00
13-1/4	71300-13-QTR	1,577.00
15-1/4	71300-15-QTR	1,661.00
17-1/4	71300-17-QTR	1,661.00

**ADD FOR OPTIONS:**

-52*	\$59.00	-91	\$209.00
-54*	270.00	-95	209.00
-72	0.00	-HD	1,221.00
-74	90.00	-HD-52	1,280.00
-81	138.00	-HD-54	1,221.00

\*SS Box Body



**71350**

QUARTER-TURN HYDRANT FOR NSF/ANSI 61		
LIST PRICE		
SIZE		
3	71350-MC-QTR	\$856.00
4	71350-4-QTR	856.00
6	71350-6-QTR	856.00
8	71350-8-QTR	856.00
10	71350-10-QTR	906.00
12	71350-12-QTR	906.00
14	71350-14-QTR	906.00

**ADD FOR OPTIONS:**

-72	\$0.00	-81	\$138.00
-74	90.00	-91	209.00



**71400**

YARD HYDRANT NON-FREEZE	
LIST PRICE	
SIZE	3/4" CONNECTION
2' Bury	\$1,150.00
3' Bury	1,210.00
4' Bury	1,275.00
5' Bury	1,335.00
6' Bury	1,397.00



**71450**

YARD HYDRANT, HEAVY-DUTY NON-FREEZE		
LIST PRICE		
SIZE	71450 3/4" Connection	71450 1" Connection
2' Bury	\$1,394.00	\$2,380.00
3' Bury	1,598.00	2,463.00
4' Bury	1,674.00	2,563.00
5' Bury	1,750.00	2,661.00
6' Bury	1,810.00	2,730.00



**71600**

YARD HYDRANT, BOX TYPE NON-FREEZE		
LIST PRICE		
SIZE	71600 3/4" Connection	71600-91 1" Connection
2' Bury	\$1,986.00	\$2,299.00
3' Bury	2,136.00	2,457.00
4' Bury	2,284.00	2,618.00
5' Bury	2,450.00	2,765.00

**ADD FOR OPTIONS:**

-52	\$0.00	-91	ABOVE
-80	2,005.00	-95	\$183.00
-81*	123.00	-97	183.00

\*Requires -80



**71650**

TRI-TEMP WALL HYDRANT, BOX TYPE NON-FREEZE		
LIST PRICE		
SIZE	71650 3/4" Connection	71650-91 1" Connection
6", 8" Wall	\$3,764.00	\$4,176.00
10", 12", 14" Wall	3,872.00	4,282.00
16", 18" Wall	4,203.00	4,613.00
20", 22", 24" Wall	4,413.00	4,825.00





**ADD FOR OPTIONS:**

-72	\$0.00	-81	\$138.00
-73	0.00	-91	ABOVE
-74	90.00	-95	183.00

## Hydrant OPTION DESCRIPTIONS

- 52 Satin Finish Bronze Face, SS Box
- 54 Satin Finish Nikaloy Face, SS Box
- 72 Wall Clamp
- 73 Solder Inlet Adapter
- 74 Union Elbow Assembly
- 80 Deep Box
- 81 Vacuum Breaker
- 91 1" Hose Pipe Threaded Outlet
- 95 Cylinder Vandal-Proof Lock
- 97 1/8" Tapped Drain Hole in Box
- HD Heavy Duty
- HD-52 Heavy Duty, Satin Finish Bronze Face, SS Box
- HD-54 Heavy Duty, Satin Finish Nikaloy Face, SS Box

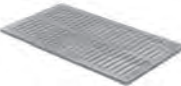
SHOCK ABSORBERS												
<p><b>75000</b></p> 	<p align="center"><b>STAINLESS STEEL SHELL &amp; ADAPTER</b></p>											
	LIST PRICE											
	SIZE											
	<table border="1"> <tr><td>A</td><td>\$546.00</td></tr> <tr><td>B</td><td>1,103.00</td></tr> <tr><td>C</td><td>1,657.00</td></tr> <tr><td>D</td><td>4,149.00</td></tr> <tr><td>E</td><td>4,682.00</td></tr> <tr><td>F</td><td>5,755.00</td></tr> </table>	A	\$546.00	B	1,103.00	C	1,657.00	D	4,149.00	E	4,682.00	F
A	\$546.00											
B	1,103.00											
C	1,657.00											
D	4,149.00											
E	4,682.00											
F	5,755.00											

TRENCH DRAINS							
<p><b>76000</b></p> 	<p><b>SUPER-FLO® 6" WIDE, RECTANGULAR</b></p>			<p><b>76010</b></p> 	<p><b>12" WIDE, RECTANGULAR</b></p>		
	LIST PRICE				LIST PRICE		
	PIPE SIZE	2", 3", 4"	\$1,027.00		PIPE SIZE	3"-6"	\$2,409.00
ADD FOR OPTIONS:			ADD FOR OPTIONS:				
-1	\$1,098.00	-ARE	\$633.00	-1	\$1,359.00	-70	\$560.00
-2	948.00	-EXT	1,027.00	-2	1,170.00	-70-40	909.00
-7	319.00	-VP	235.00	-7	877.00	-ARE	1,269.00
-30	153.00	-X	0.00	-11	185.00	-EXT	2,409.00
-40	317.00			-30	147.00	-VP	235.00
2" and 3" Provided as 4" -X with Reducer.				-40	635.00	-X	0.00
				3" Provided as 4" -X with Reducer.			
<p><b>76200</b></p> 							
<p align="center"><b>FRAME &amp; GRATE ASSEMBLY (C CLASS)</b></p>							
TYPE NO.		OVERALL WIDTH		LIST PRICE			
76210		6"		POA●			
76220		10"		POA●			
76230		14"		POA●			
● PRICE ON APPLICATION							
<p><b>76300</b> <b>76400</b></p> 	<p align="center"><b>LIGHT-DUTY RECTANGULAR TRENCH DRAIN &amp; ADDITIONAL SECTIONS</b></p>						
	LIST PRICE						
	OPTIONS	76300 20" GRATE	76301 SINGLE GRATE & FRAME	76302 2-GRATE SECTION	76302 ADD'L. 20" 1-GRATE SECTION	76402 24" 2-GRATE SECTION	7640 ADD'L. 12" SECTIONS
	\$562.00	\$1,232.00	\$2,466.00	\$1,232.00	\$2,748.00	\$909.00	
ADD FOR OPTIONS:							
-1	\$2,114.00	\$3,394.00	\$5,379.00	\$1,986.00	\$5,592.00	\$2,801.00	
-7	623.00	1,246.00	2,494.00	1,246.00	2,494.00	1,246.00	
-8-2	1,885.00	2,968.00	4,728.00	1,763.00	4,930.00	2,569.00	
-40	317.00	483.00	964.00	483.00	964.00	463.00	
-VP	N/A	464.00	931.00	464.00	931.00	464.00	
<p><b>76500</b> <b>76600</b></p> 	<p align="center"><b>MEDIUM-DUTY RECTANGULAR TRENCH DRAIN &amp; ADDITIONAL SECTIONS</b></p>						
	LIST PRICE						
	OPTIONS	76500 24" GRATE	76501 SINGLE GRATE & FRAME	76502 2-GRATE SECTION	76502 ADD'L. 24" 1-GRATE SECTION	76602 24" 2-GRATE SECTION	7660 ADD'L. 12" SECTIONS
	\$717.00	\$1,945.00	\$3,001.00	\$1,887.00	\$3,593.00	\$1,648.00	
ADD FOR OPTIONS:							
-1	\$2,688.00	\$3,861.00	\$6,860.00	\$3,001.00	\$8,039.00	\$4,176.00	
-7	1,243.00	1,243.00	2,489.00	1,243.00	2,489.00	1,243.00	
-8-2	2,496.00	3,505.00	6,205.00	2,701.00	7,215.00	3,710.00	
-40	1,361.00	1,361.00	2,720.00	1,361.00	2,720.00	1,361.00	
-VP	N/A	464.00	931.00	464.00	931.00	464.00	

## TRENCH DRAINS (cont'd)





<b>76700</b> <b>76800</b> 	HEAVY-DUTY RECTANGULAR TRENCH DRAIN & ADDITIONAL SECTIONS						
	LIST PRICE						
	OPTIONS	76700 24" GRATE	76701 SINGLE GRATE & FRAME	76702 2-GRATE SECTION	76702 ADD'L. 24" 1-GRATE SECTION	76802 24" 2-GRATE SECTION	7680 ADD'L. 12" SECTIONS
		\$1,267.00	\$2,620.00	\$4,575.00	\$1,954.00	\$3,810.00	\$1,656.00
<b>ADD FOR OPTIONS:</b>							
-1	\$4,084.00	\$6,417.00	\$12,119.00	\$5,702.00	\$10,473.00	\$4,343.00	
-7	1,344.00	1,344.00	2,687.00	1,344.00	2,687.00	1,344.00	
-8-2	3,775.00	5,639.00	10,813.00	5,179.00	9,286.00	3,892.00	
-40	1,272.00	1,526.00	3,054.00	1,526.00	3,054.00	1,526.00	
-VP	N/A	464.00	931.00	464.00	931.00	464.00	

### TRENCH DRAIN OPTION DESCRIPTIONS

-ARE	Acid Resistant Coating on Cast Iron Parts	-30	Flashing Clamp Device
-EXT	Extension Section	-40	Galvanized Cast Iron Parts
-VP	* Secured Grate, Vandal-Proof Screws	-70	Sediment Bucket
-1	Satin Finish Nikaloy Top	-70-40	Sediment Bucket, Galvanized
-2	Satin Finish Bronze Top		
-7	Ductile Iron Grate	Outlet	
-8-2	All Bronze with Satin Finish Top	-X	Inside Caulk Outlet
-11	Convex Grate		









\* For Installations Exposed to Vehicular Traffic, Specify -VP, Secured Grate







## MISCELLANEOUS PRODUCTS

<b>85220</b> 	5" x 7" 90° ANGLE STRAINER			<b>85810</b> 	RECTANGULAR PATTERN DRAIN		
	LIST PRICE				LIST PRICE		
	PIPE SIZE	2", 3", 4"	\$1,637.00		PIPE SIZE	2", 3", 4"	\$483.00
<b>ADD FOR OPTIONS:</b>				<b>ADD FOR OPTIONS:</b>			
-3	\$667.00	-47	\$582.00	-1	\$596.00	-T	\$77.00
-41	273.00	-T	0.00	-2	535.00	-TGI	POA
-42	185.00	-VP	172.00	-3	659.00	-VP	143.00
				-42	146.00	-X	0.00
				-47	488.00		
<b>85800</b> 	RECTANGULAR PATTERN DRAIN			<b>85903-Z</b> 	CAST IRON DRAIN WITH MEDIUM-DUTY SLOTTED GRATE		
	LIST PRICE				LIST PRICE		
	PIPE SIZE	4", 5", 6"	\$667.00		PIPE SIZE	3"	\$161.00
<b>ADD FOR OPTIONS:</b>				<b>ADD FOR OPTIONS:</b>			
-1	\$970.00	-47	\$582.00	-47	\$119.00	-TGI	POA
-2	870.00	-T	0.00	-F4-93	191.00	-Z	STD
-3	659.00	-TGI	POA				
-42	146.00	-VP	143.00				

### MISCELLANEOUS PRODUCT OPTION DESCRIPTIONS











-F4-93	Round Cast Iron Funnel	Outlets	
-TGI	Trap Guard Insert	-T	Threaded Outlet
-VP	Secured Grate, Vandal-Proof Screws	-X	Inside Caulk Outlet
-1	Satin Finish Nikaloy Top	-Z	No-Hub Outlet
-2	Satin Finish Bronze Top		
-3	Chrome Plated Bronze Face		
-41	Clamp Device		
-42	Ground Screw		
-47	Galvanized Cast Iron Parts		









<b>F52 &amp; F53</b> 	<b>CAST IRON THREADED FUNNEL</b>		<b>88300</b> 	<b>TRAP SEAL PRIMER VALVE</b>																							
	<table border="1"> <thead> <tr> <th colspan="2">LIST PRICE</th> </tr> <tr> <th>F52</th> <th>F53</th> </tr> </thead> <tbody> <tr> <td>\$323.00</td> <td>\$430.00</td> </tr> </tbody> </table>			LIST PRICE		F52	F53	\$323.00	\$430.00	<table border="1"> <thead> <tr> <th colspan="2">LIST PRICE</th> </tr> <tr> <th>88300</th> <th>POA*</th> </tr> </thead> <tbody> <tr> <td colspan="2">88280 Less Distribution Unit .....\$1,340.00</td> </tr> <tr> <td colspan="2">• PRICE ON APPLICATION</td> </tr> </tbody> </table>		LIST PRICE		88300	POA*	88280 Less Distribution Unit .....\$1,340.00		• PRICE ON APPLICATION									
LIST PRICE																											
F52	F53																										
\$323.00	\$430.00																										
LIST PRICE																											
88300	POA*																										
88280 Less Distribution Unit .....\$1,340.00																											
• PRICE ON APPLICATION																											
<b>88100</b> 	<b>P TRAP</b>		<b>88400</b> 	<b>NO-HUB SPIGOT ADAPTER</b>																							
	<table border="1"> <thead> <tr> <th colspan="2">LIST PRICE</th> </tr> <tr> <th>PIPE SIZE</th> <th></th> </tr> </thead> <tbody> <tr> <td>2"</td> <td>\$437.00</td> </tr> <tr> <td>3"</td> <td>667.00</td> </tr> <tr> <td>4"</td> <td>992.00</td> </tr> </tbody> </table>			LIST PRICE		PIPE SIZE		2"	\$437.00	3"	667.00	4"	992.00	<table border="1"> <thead> <tr> <th colspan="2">LIST PRICE</th> </tr> <tr> <th>PIPE SIZE</th> <th></th> </tr> </thead> <tbody> <tr> <td>2"</td> <td>\$92.00</td> </tr> <tr> <td>3"</td> <td>136.00</td> </tr> <tr> <td>4"</td> <td>216.00</td> </tr> <tr> <td>6"</td> <td>659.00</td> </tr> <tr> <td>8"</td> <td>737.00</td> </tr> </tbody> </table>		LIST PRICE		PIPE SIZE		2"	\$92.00	3"	136.00	4"	216.00	6"	659.00
LIST PRICE																											
PIPE SIZE																											
2"	\$437.00																										
3"	667.00																										
4"	992.00																										
LIST PRICE																											
PIPE SIZE																											
2"	\$92.00																										
3"	136.00																										
4"	216.00																										
6"	659.00																										
8"	737.00																										
<b>88210</b> 	<b>DEEP SEAL TRAP, FUNNEL INLET</b>		<b>88450</b> 	<b>TRAP PRIMER ADAPTER</b>																							
	<table border="1"> <thead> <tr> <th colspan="2">LIST PRICE</th> </tr> <tr> <th>PIPE SIZE</th> <th></th> </tr> </thead> <tbody> <tr> <td>2"</td> <td>\$726.00</td> </tr> <tr> <td>3"</td> <td>839.00</td> </tr> </tbody> </table>			LIST PRICE		PIPE SIZE		2"	\$726.00	3"	839.00	<table border="1"> <thead> <tr> <th colspan="2">LIST PRICE</th> </tr> <tr> <th>PIPE SIZE</th> <th>2", 3", 4"</th> </tr> </thead> <tbody> <tr> <td></td> <td>\$187.00</td> </tr> </tbody> </table>		LIST PRICE		PIPE SIZE	2", 3", 4"		\$187.00								
LIST PRICE																											
PIPE SIZE																											
2"	\$726.00																										
3"	839.00																										
LIST PRICE																											
PIPE SIZE	2", 3", 4"																										
	\$187.00																										
<b>88240</b> 	<b>TRAP GUARD INSERT</b>		<b>88550</b> 	<b>HUB ADAPTER, THREADED OUTLET</b>																							
	<table border="1"> <thead> <tr> <th colspan="2">LIST PRICE</th> </tr> <tr> <th>PIPE SIZE</th> <th></th> </tr> </thead> <tbody> <tr> <td>88242 2"</td> <td>POA</td> </tr> <tr> <td>88243 3"</td> <td>POA</td> </tr> <tr> <td>88243-1/2 3-1/2"</td> <td>POA</td> </tr> <tr> <td>88244 4"</td> <td>POA</td> </tr> </tbody> </table>			LIST PRICE		PIPE SIZE		88242 2"	POA	88243 3"	POA	88243-1/2 3-1/2"	POA	88244 4"	POA	<table border="1"> <thead> <tr> <th colspan="2">LIST PRICE</th> </tr> <tr> <th>PIPE SIZE</th> <th></th> </tr> </thead> <tbody> <tr> <td>3"</td> <td>\$147.00</td> </tr> <tr> <td>4"</td> <td>187.00</td> </tr> <tr> <td>5"</td> <td>388.00</td> </tr> <tr> <td>6"</td> <td>464.00</td> </tr> </tbody> </table>		LIST PRICE		PIPE SIZE		3"	\$147.00	4"	187.00	5"	388.00
LIST PRICE																											
PIPE SIZE																											
88242 2"	POA																										
88243 3"	POA																										
88243-1/2 3-1/2"	POA																										
88244 4"	POA																										
LIST PRICE																											
PIPE SIZE																											
3"	\$147.00																										
4"	187.00																										
5"	388.00																										
6"	464.00																										
<b>88250</b> 	<b>TRAP SEAL PRIMER VALVE</b>		<b>ADD FOR OPTIONS:</b> -40 (3", 4") ..... \$68.00    -40 (6") ..... \$119.00 -40 (5") ..... 103.00																								
	<table border="1"> <thead> <tr> <th colspan="2">LIST PRICE</th> </tr> <tr> <th>88250</th> <th>\$288.00</th> </tr> </thead> <tbody> <tr> <td colspan="2">-10 ..... \$85.00</td> </tr> </tbody> </table>		LIST PRICE		88250	\$288.00	-10 ..... \$85.00																				
LIST PRICE																											
88250	\$288.00																										
-10 ..... \$85.00																											

<p><b>88560</b></p> 	<p><b>HUB ADAPTER, THREADED OUTLET</b></p> <table border="1"> <thead> <tr> <th colspan="2">LIST PRICE</th> </tr> <tr> <th>PIPE SIZE</th> <th></th> </tr> </thead> <tbody> <tr> <td>2"</td> <td>\$92.00</td> </tr> <tr> <td>3"</td> <td>176.00</td> </tr> <tr> <td>4"</td> <td>235.00</td> </tr> <tr> <td>5"</td> <td>388.00</td> </tr> <tr> <td>6"</td> <td>450.00</td> </tr> <tr> <td>8"</td> <td>824.00</td> </tr> </tbody> </table> <p><b>ADD FOR OPTIONS:</b></p> <p>-40 (2" - 4") ..... \$77.00    -40 (5" - 8")..... \$120.00</p>	LIST PRICE		PIPE SIZE		2"	\$92.00	3"	176.00	4"	235.00	5"	388.00	6"	450.00	8"	824.00	<p><b>88950</b></p> 	<p><b>FRESH AIR INLET</b></p> <table border="1"> <thead> <tr> <th colspan="2">LIST PRICE</th> </tr> <tr> <th>PIPE SIZE</th> <th></th> </tr> </thead> <tbody> <tr> <td>2", 3", 4"</td> <td>\$568.00</td> </tr> <tr> <td>5", 6"</td> <td>970.00</td> </tr> <tr> <td>8"</td> <td>1,547.00</td> </tr> </tbody> </table> <p><b>ADD FOR OPTIONS:</b></p> <p>-2 (2" - 4")..... Deduct \$87.00    -2 (8")..... Deduct \$369.00          -2 (5", 6") ..... Deduct 209.00</p>	LIST PRICE		PIPE SIZE		2", 3", 4"	\$568.00	5", 6"	970.00	8"	1,547.00						
LIST PRICE																																			
PIPE SIZE																																			
2"	\$92.00																																		
3"	176.00																																		
4"	235.00																																		
5"	388.00																																		
6"	450.00																																		
8"	824.00																																		
LIST PRICE																																			
PIPE SIZE																																			
2", 3", 4"	\$568.00																																		
5", 6"	970.00																																		
8"	1,547.00																																		
<p><b>88600</b></p> 	<p><b>REDUCING HUB ADAPTER</b></p> <table border="1"> <thead> <tr> <th colspan="3">LIST PRICE</th> </tr> <tr> <th>TYPE NO.</th> <th>PIPE SIZE</th> <th></th> </tr> </thead> <tbody> <tr> <td>88603-2</td> <td>2"</td> <td>\$243.00</td> </tr> <tr> <td>88603-2-1/2</td> <td>2-1/2"</td> <td>256.00</td> </tr> <tr> <td>88604-2</td> <td>2"</td> <td>256.00</td> </tr> <tr> <td>88604-2-1/2</td> <td>2-1/2"</td> <td>256.00</td> </tr> <tr> <td>88604-3</td> <td>3"</td> <td>259.00</td> </tr> <tr> <td>88606-4</td> <td>4"</td> <td>549.00</td> </tr> </tbody> </table> <p><b>ADD FOR OPTIONS:</b></p> <p>-40 ..... \$77.00</p>	LIST PRICE			TYPE NO.	PIPE SIZE		88603-2	2"	\$243.00	88603-2-1/2	2-1/2"	256.00	88604-2	2"	256.00	88604-2-1/2	2-1/2"	256.00	88604-3	3"	259.00	88606-4	4"	549.00	<p><b>88970</b></p> 	<p><b>FRESH AIR INLET</b></p> <table border="1"> <thead> <tr> <th colspan="2">LIST PRICE</th> </tr> <tr> <th>PIPE SIZE</th> <th></th> </tr> </thead> <tbody> <tr> <td>4"</td> <td>\$900.00</td> </tr> <tr> <td>5"</td> <td>1,025.00</td> </tr> </tbody> </table> <p><b>ADD FOR OPTIONS:</b></p> <p>-8-2 ..... Deduct \$324.00    -VP ..... \$65.00</p>	LIST PRICE		PIPE SIZE		4"	\$900.00	5"	1,025.00
LIST PRICE																																			
TYPE NO.	PIPE SIZE																																		
88603-2	2"	\$243.00																																	
88603-2-1/2	2-1/2"	256.00																																	
88604-2	2"	256.00																																	
88604-2-1/2	2-1/2"	256.00																																	
88604-3	3"	259.00																																	
88606-4	4"	549.00																																	
LIST PRICE																																			
PIPE SIZE																																			
4"	\$900.00																																		
5"	1,025.00																																		
<p><b>88900</b></p> 	<p><b>AIR GAP</b></p> <table border="1"> <thead> <tr> <th colspan="2">LIST PRICE</th> </tr> <tr> <th>TYPE NO.</th> <th></th> </tr> </thead> <tbody> <tr> <td>88900-1</td> <td>\$297.00</td> </tr> <tr> <td>88900-2</td> <td>297.00</td> </tr> <tr> <td>88900-3</td> <td>356.00</td> </tr> <tr> <td>88900-4</td> <td>526.00</td> </tr> <tr> <td>88900-5</td> <td>1,242.00</td> </tr> </tbody> </table> <p><b>ADD FOR OPTIONS:</b></p> <p>-40 ..... \$207.00</p>	LIST PRICE		TYPE NO.		88900-1	\$297.00	88900-2	297.00	88900-3	356.00	88900-4	526.00	88900-5	1,242.00	<p><b>OPTION DESCRIPTIONS</b></p> <ul style="list-style-type: none"> <li>-ARE    Acid-Resisting Epoxy</li> <li>-VP    Secured Grate, Vandal-Proof Screws</li> <li>-2      Satin Finish Bronze Face</li> <li>-8      All Bronze</li> <li>-8-2    All Bronze with Satin Finish Face</li> <li>-10     Polished Chrome Plated</li> <li>-40     Galvanized Cast Iron Parts</li> <li>-49     3/4" Primer Tap</li> <li>-50     1/2" Primer Tap</li> <li>-51     Flushing Tap</li> <li>-60     Bronze Plug</li> <li>-72     Bronze Bucket</li> <li>-90     1/2" Female Copper Connection</li> <li>-91     1/2" Female Copper Union Connection</li> </ul>																			
LIST PRICE																																			
TYPE NO.																																			
88900-1	\$297.00																																		
88900-2	297.00																																		
88900-3	356.00																																		
88900-4	526.00																																		
88900-5	1,242.00																																		
<p><b>88910</b></p> 	<p><b>AIR GAP</b></p> <table border="1"> <thead> <tr> <th colspan="2">LIST PRICE</th> </tr> <tr> <th>TYPE NO.</th> <th></th> </tr> </thead> <tbody> <tr> <td>88910-1</td> <td>\$308.00</td> </tr> <tr> <td>88910-2</td> <td>308.00</td> </tr> <tr> <td>88910-3</td> <td>334.00</td> </tr> <tr> <td>88910-4</td> <td>428.00</td> </tr> <tr> <td>88910-5</td> <td>428.00</td> </tr> </tbody> </table> <p><b>ADD FOR OPTIONS:</b></p> <p>-40 ..... \$207.00</p>	LIST PRICE		TYPE NO.		88910-1	\$308.00	88910-2	308.00	88910-3	334.00	88910-4	428.00	88910-5	428.00																				
LIST PRICE																																			
TYPE NO.																																			
88910-1	\$308.00																																		
88910-2	308.00																																		
88910-3	334.00																																		
88910-4	428.00																																		
88910-5	428.00																																		

# LITE LINE FLOOR DRAINS



 <p><b>FD-100-A</b></p>	<p><b>LEVEZE II™ C.I. BODY WITH 5" ROUND TOP WITH TWO-STAGE HEIGHT ADJUSTMENT</b></p> <table border="1"> <tr><th colspan="2">LIST PRICE</th></tr> <tr> <th>PIPE SIZE</th> <th>FD-100-A</th> </tr> <tr> <td>2"-5"*</td> <td>\$420.00</td> </tr> </table> <p><b>ADD FOR OPTIONS:</b></p> <table> <tr> <td>-TGI † .....</td> <td>POA</td> <td>-Y .....</td> <td>\$0.00</td> </tr> <tr> <td>-VP .....</td> <td>\$19.00</td> <td>-Z .....</td> <td>0.00</td> </tr> </table> <p>* 5" available in no-hub only † Available up to 4" only</p>	LIST PRICE		PIPE SIZE	FD-100-A	2"-5"*	\$420.00	-TGI † .....	POA	-Y .....	\$0.00	-VP .....	\$19.00	-Z .....	0.00	 <p><b>FD-210-4CP-SQ</b></p>	<p><b>PVC BODY WITH SOLVENT WELD OUTLET AND 4" ADJUSTABLE SQUARE CHROME PLATED BRASS STRAINER</b></p> <table border="1"> <tr><th colspan="2">LIST PRICE</th></tr> <tr> <th>PIPE SIZE</th> <th>FD-210-4CP-SQ</th> </tr> <tr> <td>2", 3", 4"</td> <td>\$242.00</td> </tr> </table> <p><b>ADD FOR OPTIONS:</b></p> <table> <tr> <td>-TGI .....</td> <td>POA</td> </tr> </table>	LIST PRICE		PIPE SIZE	FD-210-4CP-SQ	2", 3", 4"	\$242.00	-TGI .....	POA																															
LIST PRICE																																																								
PIPE SIZE	FD-100-A																																																							
2"-5"*	\$420.00																																																							
-TGI † .....	POA	-Y .....	\$0.00																																																					
-VP .....	\$19.00	-Z .....	0.00																																																					
LIST PRICE																																																								
PIPE SIZE	FD-210-4CP-SQ																																																							
2", 3", 4"	\$242.00																																																							
-TGI .....	POA																																																							
 <p><b>FD-100-S</b></p>	<p><b>LEVEZE II™ C.I. BODY WITH 5" SQUARE TOP WITH TWO-STAGE HEIGHT ADJUSTMENT</b></p> <table border="1"> <tr><th colspan="2">LIST PRICE</th></tr> <tr> <th>PIPE SIZE</th> <th>FD-100-S</th> </tr> <tr> <td>2"-5"*</td> <td>\$490.00</td> </tr> </table> <p><b>ADD FOR OPTIONS:</b></p> <table> <tr> <td>-TGI † .....</td> <td>POA</td> <td>-Y .....</td> <td>\$0.00</td> </tr> <tr> <td>-VP .....</td> <td>\$19.00</td> <td>-Z .....</td> <td>0.00</td> </tr> </table> <p>* 5" available in no-hub only † Available up to 4" only</p>	LIST PRICE		PIPE SIZE	FD-100-S	2"-5"*	\$490.00	-TGI † .....	POA	-Y .....	\$0.00	-VP .....	\$19.00	-Z .....	0.00	 <p><b>4CP &amp; 4CP-SQ</b></p>	<p><b>REPLACEMENT CHROME PLATED STRAINERS FOR FD-200 AND FD-210 SERIES</b></p> <table border="1"> <tr><th colspan="2">LIST PRICE</th></tr> <tr> <th>4CP</th> <th>\$153.00</th> </tr> <tr> <th>4CP-SQ</th> <th>177.00</th> </tr> </table> <p><b>ADD FOR OPTIONS:</b></p> <table> <tr> <td>-TGI .....</td> <td>POA</td> </tr> </table>	LIST PRICE		4CP	\$153.00	4CP-SQ	177.00	-TGI .....	POA																															
LIST PRICE																																																								
PIPE SIZE	FD-100-S																																																							
2"-5"*	\$490.00																																																							
-TGI † .....	POA	-Y .....	\$0.00																																																					
-VP .....	\$19.00	-Z .....	0.00																																																					
LIST PRICE																																																								
4CP	\$153.00																																																							
4CP-SQ	177.00																																																							
-TGI .....	POA																																																							
 <p><b>FD-200-4CP</b></p>	<p><b>CAST IRON BODY WITH 4" ADJUSTABLE ROUND CHROME PLATED BRASS STRAINER</b></p> <table border="1"> <tr><th colspan="2">LIST PRICE</th></tr> <tr> <th>PIPE SIZE</th> <th>FD-200-4CP</th> </tr> <tr> <td>2"</td> <td>\$229.00</td> </tr> </table> <p><b>ADD FOR OPTIONS:</b></p> <table> <tr> <td>-ST .....</td> <td>\$171.00</td> <td>-TGI .....</td> <td>POA</td> </tr> <tr> <td>-T .....</td> <td>0.00</td> <td>-Z .....</td> <td>0.00</td> </tr> </table>	LIST PRICE		PIPE SIZE	FD-200-4CP	2"	\$229.00	-ST .....	\$171.00	-TGI .....	POA	-T .....	0.00	-Z .....	0.00	 <p><b>FD-220</b></p>	<p><b>CAST IRON BODY WITH 6" SLOTTED CAST IRON, MEDIUM-DUTY GRATE</b></p> <table border="1"> <tr><th colspan="2">LIST PRICE</th></tr> <tr> <th>PIPE SIZE</th> <th>FD-220</th> </tr> <tr> <td>2" Push-On (-Y)</td> <td>\$98.00</td> </tr> <tr> <td>3" No-Hub</td> <td>98.00</td> </tr> </table> <p><b>ADD FOR OPTIONS:</b></p> <table> <tr> <td>-TGI .....</td> <td>POA</td> </tr> </table>	LIST PRICE		PIPE SIZE	FD-220	2" Push-On (-Y)	\$98.00	3" No-Hub	98.00	-TGI .....	POA																													
LIST PRICE																																																								
PIPE SIZE	FD-200-4CP																																																							
2"	\$229.00																																																							
-ST .....	\$171.00	-TGI .....	POA																																																					
-T .....	0.00	-Z .....	0.00																																																					
LIST PRICE																																																								
PIPE SIZE	FD-220																																																							
2" Push-On (-Y)	\$98.00																																																							
3" No-Hub	98.00																																																							
-TGI .....	POA																																																							
 <p><b>FD-200-4CP-SQ</b></p>	<p><b>CAST IRON BODY WITH 4" ADJUSTABLE SQUARE CHROME PLATED BRASS STRAINER</b></p> <table border="1"> <tr><th colspan="2">LIST PRICE</th></tr> <tr> <th>PIPE SIZE</th> <th>FD-200-4CP-SQ</th> </tr> <tr> <td>2"</td> <td>\$253.00</td> </tr> </table> <p><b>ADD FOR OPTIONS:</b></p> <table> <tr> <td>-ST .....</td> <td>\$171.00</td> <td>-TGI .....</td> <td>POA</td> </tr> <tr> <td>-T .....</td> <td>0.00</td> <td>-Z .....</td> <td>0.00</td> </tr> </table>	LIST PRICE		PIPE SIZE	FD-200-4CP-SQ	2"	\$253.00	-ST .....	\$171.00	-TGI .....	POA	-T .....	0.00	-Z .....	0.00	 <p><b>FD-250J-A</b></p>	<p><b>CAST IRON BODY WITH ADJUSTABLE ROUND NIKALOY STRAINER AND NO-HUB BOTTOM OUTLET</b></p> <table border="1"> <tr><th colspan="5">LIST PRICE</th></tr> <tr> <th rowspan="2">PIPE SIZE</th> <th colspan="4">WITH STRAINER</th> </tr> <tr> <th>5A</th> <th>6A</th> <th>7A</th> <th>8A</th> </tr> <tr> <td>4"</td> <td>\$304.00</td> <td>\$391.00</td> <td>\$464.00</td> <td>\$604.00</td> </tr> </table> <p><b>ADD FOR OPTIONS:</b></p> <table> <tr> <td>-2 .....</td> <td>Deduct \$26.00</td> <td>-CP (6A) .....</td> <td>\$103.00</td> </tr> <tr> <td>-80 .....</td> <td>24.00</td> <td>-J .....</td> <td>109.00</td> </tr> <tr> <td>-92 .....</td> <td>17.00</td> <td>-SS .....</td> <td>55.00</td> </tr> <tr> <td>-ARE .....</td> <td>22.00</td> <td>-TGI .....</td> <td>POA</td> </tr> <tr> <td>-CP (5A) .....</td> <td>103.00</td> <td>-VP .....</td> <td>19.00</td> </tr> </table>	LIST PRICE					PIPE SIZE	WITH STRAINER				5A	6A	7A	8A	4"	\$304.00	\$391.00	\$464.00	\$604.00	-2 .....	Deduct \$26.00	-CP (6A) .....	\$103.00	-80 .....	24.00	-J .....	109.00	-92 .....	17.00	-SS .....	55.00	-ARE .....	22.00	-TGI .....	POA	-CP (5A) .....	103.00	-VP .....	19.00
LIST PRICE																																																								
PIPE SIZE	FD-200-4CP-SQ																																																							
2"	\$253.00																																																							
-ST .....	\$171.00	-TGI .....	POA																																																					
-T .....	0.00	-Z .....	0.00																																																					
LIST PRICE																																																								
PIPE SIZE	WITH STRAINER																																																							
	5A	6A	7A	8A																																																				
4"	\$304.00	\$391.00	\$464.00	\$604.00																																																				
-2 .....	Deduct \$26.00	-CP (6A) .....	\$103.00																																																					
-80 .....	24.00	-J .....	109.00																																																					
-92 .....	17.00	-SS .....	55.00																																																					
-ARE .....	22.00	-TGI .....	POA																																																					
-CP (5A) .....	103.00	-VP .....	19.00																																																					
 <p><b>FD-210-4CP</b></p>	<p><b>PVC BODY WITH SOLVENT WELD OUTLET AND 4" ADJUSTABLE ROUND CHROME PLATED BRASS STRAINER</b></p> <table border="1"> <tr><th colspan="2">LIST PRICE</th></tr> <tr> <th>PIPE SIZE</th> <th>FD-210-4CP</th> </tr> <tr> <td>2"</td> <td>\$218.00</td> </tr> </table> <p><b>ADD FOR OPTIONS:</b></p> <table> <tr> <td>-TGI .....</td> <td>POA</td> </tr> </table>	LIST PRICE		PIPE SIZE	FD-210-4CP	2"	\$218.00	-TGI .....	POA	 <p><b>FD-250J-S</b></p>	<p><b>CAST IRON BODY WITH ADJUSTABLE SQUARE NIKALOY STRAINER AND NO-HUB BOTTOM OUTLET</b></p> <table border="1"> <tr><th colspan="4">LIST PRICE</th></tr> <tr> <th rowspan="2">PIPE SIZE</th> <th colspan="3">WITH STRAINER</th> </tr> <tr> <th>5S</th> <th>6S</th> <th>8S</th> </tr> <tr> <td>4"</td> <td>\$435.00</td> <td>\$494.00</td> <td>\$754.00</td> </tr> </table> <p><b>ADD FOR OPTIONS:</b></p> <table> <tr> <td>-2 .....</td> <td>Deduct \$26.00</td> <td>-CP (6S) .....</td> <td>\$103.00</td> </tr> <tr> <td>-80 .....</td> <td>24.00</td> <td>-J .....</td> <td>109.00</td> </tr> <tr> <td>-92 .....</td> <td>17.00</td> <td>-SS .....</td> <td>55.00</td> </tr> <tr> <td>-ARE .....</td> <td>22.00</td> <td>-TGI .....</td> <td>POA</td> </tr> <tr> <td>-CP (5S) .....</td> <td>103.00</td> <td>-VP .....</td> <td>19.00</td> </tr> </table>	LIST PRICE				PIPE SIZE	WITH STRAINER			5S	6S	8S	4"	\$435.00	\$494.00	\$754.00	-2 .....	Deduct \$26.00	-CP (6S) .....	\$103.00	-80 .....	24.00	-J .....	109.00	-92 .....	17.00	-SS .....	55.00	-ARE .....	22.00	-TGI .....	POA	-CP (5S) .....	103.00	-VP .....	19.00										
LIST PRICE																																																								
PIPE SIZE	FD-210-4CP																																																							
2"	\$218.00																																																							
-TGI .....	POA																																																							
LIST PRICE																																																								
PIPE SIZE	WITH STRAINER																																																							
	5S	6S	8S																																																					
4"	\$435.00	\$494.00	\$754.00																																																					
-2 .....	Deduct \$26.00	-CP (6S) .....	\$103.00																																																					
-80 .....	24.00	-J .....	109.00																																																					
-92 .....	17.00	-SS .....	55.00																																																					
-ARE .....	22.00	-TGI .....	POA																																																					
-CP (5S) .....	103.00	-VP .....	19.00																																																					

 <p><b>FD-300</b></p>	<p><b>PVC 2-PIECE FLOOR DRAIN BODY ONLY WITH 1/2" PRIMER TAP WITH PLUG AND SOLVENT WELD BOTTOM OUTLET FOR SCH 40 PVC PIPE</b></p> <table border="1"> <thead> <tr> <th colspan="2">LIST PRICE</th> </tr> <tr> <th>PIPE SIZE</th> <th>FD-300</th> </tr> </thead> <tbody> <tr> <td>2", 3", 4"</td> <td>\$144.00</td> </tr> </tbody> </table> <p><b>ADD FOR OPTIONS:</b> -TGI.....POA</p>	LIST PRICE		PIPE SIZE	FD-300	2", 3", 4"	\$144.00	 <p><b>FD-350-A</b></p>	<p><b>PVC 2-PIECE FLOOR DRAIN WITH 1/2" PRIMER TAP WITH PLUG, SOLVENT WELD BOTTOM OUTLET FOR SCH 40 PVC PIPE AND 5" ADJUSTABLE PVC ROUND STRAINER WITH METAL RIM AND GRATE</b></p> <table border="1"> <thead> <tr> <th colspan="3">LIST PRICE</th> </tr> <tr> <th>PIPE SIZE</th> <th colspan="2">WITH STRAINER</th> </tr> </thead> <tbody> <tr> <td>2", 3", 4"</td> <td>-5NBRG Nickel Bronze</td> <td>\$330.00</td> </tr> <tr> <td>2", 3", 4"</td> <td>-5PBRG Polished Bronze</td> <td>330.00</td> </tr> <tr> <td>2", 3", 4"</td> <td>-5SCRG Scoriated Gasketed Solid Cover</td> <td>380.00</td> </tr> </tbody> </table> <p><b>ADD FOR OPTIONS:</b> -SQ.....\$0.00    -VP.....\$19.00 -TGI.....POA</p>	LIST PRICE			PIPE SIZE	WITH STRAINER		2", 3", 4"	-5NBRG Nickel Bronze	\$330.00	2", 3", 4"	-5PBRG Polished Bronze	330.00	2", 3", 4"	-5SCRG Scoriated Gasketed Solid Cover	380.00													
LIST PRICE																																					
PIPE SIZE	FD-300																																				
2", 3", 4"	\$144.00																																				
LIST PRICE																																					
PIPE SIZE	WITH STRAINER																																				
2", 3", 4"	-5NBRG Nickel Bronze	\$330.00																																			
2", 3", 4"	-5PBRG Polished Bronze	330.00																																			
2", 3", 4"	-5SCRG Scoriated Gasketed Solid Cover	380.00																																			
 <p><b>FD-300-A</b></p>	<p><b>PVC 2-PIECE FLOOR DRAIN WITH 1/2" PRIMER TAP WITH PLUG, SOLVENT WELD BOTTOM OUTLET FOR SCH 40 PVC PIPE AND 5" ADJUSTABLE ROUND STRAINER</b></p> <table border="1"> <thead> <tr> <th colspan="3">LIST PRICE</th> </tr> <tr> <th>PIPE SIZE</th> <th colspan="2">WITH STRAINER</th> </tr> </thead> <tbody> <tr> <td>2", 3", 4"</td> <td>-J5PVC</td> <td>\$179.00</td> </tr> <tr> <td>2", 3", 4"</td> <td>-J5NB Nickel Bronze</td> <td>232.00</td> </tr> <tr> <td>2", 3", 4"</td> <td>-J5SC Scoriated Gasketed Solid Cover</td> <td>232.00</td> </tr> </tbody> </table> <p><b>ADD FOR OPTIONS:</b> -TGI.....POA</p>	LIST PRICE			PIPE SIZE	WITH STRAINER		2", 3", 4"	-J5PVC	\$179.00	2", 3", 4"	-J5NB Nickel Bronze	232.00	2", 3", 4"	-J5SC Scoriated Gasketed Solid Cover	232.00	 <p><b>FD-370</b></p>	<p><b>PVC FLOOR DRAIN WITH FLANGE, 9" PVC GRATE AND SOLVENT WELD BOTTOM OUTLET FOR SCH 40 PVC PIPE</b></p> <table border="1"> <thead> <tr> <th colspan="2">LIST PRICE</th> </tr> <tr> <th>PIPE SIZE</th> <th>FD-370</th> </tr> </thead> <tbody> <tr> <td>2", 3", 4"</td> <td>\$359.00</td> </tr> </tbody> </table> <p><b>ADD FOR OPTIONS:</b> -49.....\$76.00    -B.....\$81.00 -50.....76.00    -HG.....0.00 -TGI.....POA</p>	LIST PRICE		PIPE SIZE	FD-370	2", 3", 4"	\$359.00													
LIST PRICE																																					
PIPE SIZE	WITH STRAINER																																				
2", 3", 4"	-J5PVC	\$179.00																																			
2", 3", 4"	-J5NB Nickel Bronze	232.00																																			
2", 3", 4"	-J5SC Scoriated Gasketed Solid Cover	232.00																																			
LIST PRICE																																					
PIPE SIZE	FD-370																																				
2", 3", 4"	\$359.00																																				
 <p><b>FD-300J-A</b></p>	<p><b>PVC 2-PIECE FLOOR DRAIN WITH 1/2" PRIMER TAP WITH PLUG, SOLVENT WELD BOTTOM OUTLET FOR SCH 40 PVC PIPE AND ADJUSTABLE ROUND NIKALOY STRAINER</b></p> <table border="1"> <thead> <tr> <th colspan="5">LIST PRICE</th> </tr> <tr> <th rowspan="2">PIPE SIZE</th> <th colspan="4">WITH STRAINER</th> </tr> <tr> <th>5A</th> <th>6A</th> <th>7A</th> <th>8A</th> </tr> </thead> <tbody> <tr> <td>2", 3", 4"</td> <td>\$364.00</td> <td>\$451.00</td> <td>\$524.00</td> <td>\$664.00</td> </tr> </tbody> </table> <p><b>ADD FOR OPTIONS:</b> -2.....Deduct \$26.00    -CP.....\$103.00 -49.....76.00    -TGI.....POA -VP.....19.00</p>	LIST PRICE					PIPE SIZE	WITH STRAINER				5A	6A	7A	8A	2", 3", 4"	\$364.00	\$451.00	\$524.00	\$664.00	 <p><b>FD-400</b></p>	<p><b>PVC FLOOR DRAIN WITH SOLVENT WELD BOTTOM OUTLET FOR SCH 40 PVC PIPE AND 5" ADJUSTABLE ROUND STRAINER</b></p> <table border="1"> <thead> <tr> <th colspan="3">LIST PRICE</th> </tr> <tr> <th>PIPE SIZE</th> <th colspan="2">WITH STRAINER</th> </tr> </thead> <tbody> <tr> <td>3" x 4"</td> <td>-J5PVC</td> <td>\$109.00</td> </tr> <tr> <td>3" x 4"</td> <td>-J5NB Nickel Bronze</td> <td>120.00</td> </tr> <tr> <td>3" x 4"</td> <td>-J5SC Scoriated Gasketed Solid Cover</td> <td>120.00</td> </tr> </tbody> </table> <p><b>ADD FOR OPTIONS:</b> -TGI.....POA    -VP.....\$19.00</p>	LIST PRICE			PIPE SIZE	WITH STRAINER		3" x 4"	-J5PVC	\$109.00	3" x 4"	-J5NB Nickel Bronze	120.00	3" x 4"	-J5SC Scoriated Gasketed Solid Cover	120.00
LIST PRICE																																					
PIPE SIZE	WITH STRAINER																																				
	5A	6A	7A	8A																																	
2", 3", 4"	\$364.00	\$451.00	\$524.00	\$664.00																																	
LIST PRICE																																					
PIPE SIZE	WITH STRAINER																																				
3" x 4"	-J5PVC	\$109.00																																			
3" x 4"	-J5NB Nickel Bronze	120.00																																			
3" x 4"	-J5SC Scoriated Gasketed Solid Cover	120.00																																			
 <p><b>FD-300J-S</b></p>	<p><b>PVC 2-PIECE FLOOR DRAIN WITH 1/2" PRIMER TAP WITH PLUG, SOLVENT WELD BOTTOM OUTLET FOR SCH 40 PVC PIPE AND ADJUSTABLE SQUARE NIKALOY STRAINER</b></p> <table border="1"> <thead> <tr> <th colspan="4">LIST PRICE</th> </tr> <tr> <th rowspan="2">PIPE SIZE</th> <th colspan="3">WITH STRAINER</th> </tr> <tr> <th>5S</th> <th>6S</th> <th>8S</th> </tr> </thead> <tbody> <tr> <td>2", 3", 4"</td> <td>\$496.00</td> <td>\$556.00</td> <td>\$814.00</td> </tr> </tbody> </table> <p><b>ADD FOR OPTIONS:</b> -2.....Deduct \$26.00    -CP.....\$103.00 -49.....76.00    -TGI.....POA -VP.....19.00</p>	LIST PRICE				PIPE SIZE	WITH STRAINER			5S	6S	8S	2", 3", 4"	\$496.00	\$556.00	\$814.00	<p><b>Lite Line Floor Drain OPTION DESCRIPTIONS</b></p> <ul style="list-style-type: none"> <li>-B Bucket, PVC</li> <li>-CP Chrome Plated</li> <li>-HG 1/2 Grate, PVC</li> <li>-J Backwater Valve</li> <li>-MD PVC Clamp Collar with 3" Socket Connection</li> <li>-SQ Square Rim</li> <li>-SS Stainless Steel</li> <li>-ST Shallow Trap</li> <li>-TGI Trap Guard Insert</li> <li>-VP Secured Grate, Vandal-Proof Screws</li> <li>-2 Satin Finish Bronze Top</li> <li>-49 3/4" Primer Tap</li> <li>-50 1/2" Primer Tap</li> <li>-80 Perforated Stainless Steel Basket</li> <li>-92 Galvanized Cast Iron Parts</li> </ul> <p><b>Outlet</b></p> <ul style="list-style-type: none"> <li>-T Threaded Outlet</li> <li>-Y Hub Outlet with Gasket</li> <li>-Z No-Hub Outlet</li> </ul>																				
LIST PRICE																																					
PIPE SIZE	WITH STRAINER																																				
	5S	6S	8S																																		
2", 3", 4"	\$496.00	\$556.00	\$814.00																																		
 <p><b>FD-310</b></p>	<p><b>CAST IRON 2-PIECE FLOOR DRAIN WITH 1/2" TRAP PRIMER WITH PLUG AND 5" ADJUSTABLE ROUND NIKALOY STRAINER</b></p> <table border="1"> <thead> <tr> <th colspan="3">LIST PRICE</th> </tr> <tr> <th>TYPE NO.</th> <th>PIPE SIZE</th> <th></th> </tr> </thead> <tbody> <tr> <td>FD-312-Y</td> <td>2"</td> <td>\$217.00</td> </tr> <tr> <td>FD-312-Z</td> <td>2"</td> <td>217.00</td> </tr> <tr> <td>FD-313-Z</td> <td>3"</td> <td>217.00</td> </tr> <tr> <td>FD-313-Y</td> <td>3"</td> <td>217.00</td> </tr> <tr> <td>FD-314-Z</td> <td>4"</td> <td>217.00</td> </tr> </tbody> </table> <p><b>ADD FOR OPTIONS:</b> -80.....\$26.00    -VP.....\$21.00 -TGI.....POA</p>	LIST PRICE			TYPE NO.	PIPE SIZE		FD-312-Y	2"	\$217.00	FD-312-Z	2"	217.00	FD-313-Z	3"	217.00	FD-313-Y	3"	217.00	FD-314-Z	4"	217.00															
LIST PRICE																																					
TYPE NO.	PIPE SIZE																																				
FD-312-Y	2"	\$217.00																																			
FD-312-Z	2"	217.00																																			
FD-313-Z	3"	217.00																																			
FD-313-Y	3"	217.00																																			
FD-314-Z	4"	217.00																																			

## LITE LINE FLOOR DRAINS (cont'd.)

**FD-450**



**PVC FLOOR DRAIN WITH SOLVENT WELD BOTTOM OUTLET FOR SCH 40 PVC PIPE AND 5" ADJUSTABLE ROUND STRAINER WITH METAL RIM AND GRATE**

LIST PRICE		
PIPE SIZE	WITH STRAINER	
3" x 4"	-J5NBRG Nickel Bronze Rim and Grate	\$229.00
3" x 4"	-J5PBRG Polished Bronze Rim and Grate	310.00
3" x 4"	-J5SCRG Scoriated Gasketed Solid Cover	229.00

**ADD FOR OPTIONS:**

-SQ ..... \$0.00    -VP ..... \$19.00  
 -TGI ..... POA

**FD-450J-A**



**PVC FLOOR DRAIN WITH SOLVENT WELD BOTTOM OUTLET FOR SCH 40 PVC PIPE AND ADJUSTABLE ROUND NIKALOY STRAINER**

LIST PRICE				
PIPE SIZE	STRAINER			
3" x 4"	5A	6A	7A	8A
	\$286.00	\$373.00	\$447.00	\$586.00

**ADD FOR OPTIONS:**

-2 ..... Deduct \$26.00    -VP ..... \$19.00  
 -TGI ..... POA

**FD-450J-S**



**PVC FLOOR DRAIN WITH SOLVENT WELD BOTTOM OUTLET FOR SCH 40 PVC PIPE AND ADJUSTABLE SQUARE NIKALOY STRAINER**

LIST PRICE			
PIPE SIZE	WITH STRAINER		
3" x 4"	5S	6S	8S
	\$417.00	\$477.00	\$736.00

**ADD FOR OPTIONS:**

-2 ..... Deduct \$26.00    -VP ..... \$19.00  
 -TGI ..... POA

**FD-500**



**PVC FLOOR DRAIN WITH SOLVENT WELD BOTTOM OUTLET FOR SCH 40 PVC PIPE AND 5" ADJUSTABLE ROUND STRAINER**

LIST PRICE		
PIPE SIZE	WITH STRAINER	
2", 3", 4"	-J5PVC	\$88.00
2", 3", 4"	-J5NB Nickel Bronze	88.00
2", 3", 4"	-J5SC Scoriated Gasketed Solid Cover	98.00

**ADD FOR OPTIONS:**

-TGI ..... POA

**Lite Line Floor Drain OPTION DESCRIPTIONS**

-SQ    Square Rim  
 -TGI    Trap Guard Insert  
 -VP    Secured Grate, Vandal-Proof Screws  
 -2    Satin Finish Bronze Top

## LITE LINE ROOF DRAINS

**RD-300**



**PVC BODY WITH CAST IRON CLAMP RING, CAST IRON DOME AND SOLVENT WELD BOTTOM OUTLET**

LIST PRICE	
PIPE SIZE	RD-300
2", 3", 4"	\$365.00

**ADD FOR OPTIONS:**

-17 ..... \$147.00    -UC ..... \$114.00  
 -R ..... 114.00    -VP ..... 19.00  
 -RC ..... 65.00

**RD-700**



**FITSALL CLAMP RING AND HARDWARE FOR BOLT CENTERS 7-1/2" TO 11"**

LIST PRICE	
RD-700	
	\$356.00

**RD-700 TOP ASSY.**



**FITSALL TOP ASSEMBLY WITH CAST IRON CLAMP RING, LARGE DOME AND HARDWARE**

LIST PRICE		
700-AD	Aluminum Dome	\$642.00
700-CD	Cast Iron Dome	625.00
700-PD	Polypropylene Dome	532.00











**ADD FOR OPTIONS:**

-VP ..... \$19.00

**Lite Line Roof Drain OPTION DESCRIPTIONS**

-R    Drain Receiver  
 -RC    Drain Receiver and Clips  
 -UC    Underdeck Clamp  
 -VP    Secured Dome, Vandal-Proof Screws  
 -17    2" High Overflow Collar



LITE LINE FLOOR SINKS		LITE LINE CLEANOUTS					
	<b>12x12x6 PVC FLOOR SINK WITH MEDIUM-DUTY FULL PVC GRATE, ALUMINUM INTERNAL DOME STRAINER AND SOLVENT WELD OUTLET FOR SCH 40 PVC PIPE</b>			<b>LEVELZE II™ C.I. CLEANOUT WITH 5" ROUND TOP, INTERNAL PLUG AND TWO-STAGE HEIGHT ADJUSTMENT</b>			
	LIST PRICE			LIST PRICE			
	PIPE SIZE	FS-940		PIPE SIZE	CO-100-A		
	2", 3", 4"	\$534.00		2"-5"*	\$420.00		
ADD FOR OPTIONS:				ADD FOR OPTIONS:			
-3Q .....	\$0.00	-LG .....	Deduct \$133.00	-VP .....	\$19.00	-Z .....	\$0.00
-HG .....	0.00	-TGI .....	POA	-Y .....	0.00	* 5" available in no-hub only	
	<b>8x8x6 ACID-RESISTING INTERIOR FLOOR SINK AND FULL GRATE WITH ALUMINUM INTERNAL DOME STRAINER AND NO-HUB OUTLET</b>			<b>LEVELZE II™ C.I. CLEANOUT WITH 5" SQUARE TOP, INTERNAL PLUG AND TWO-STAGE HEIGHT ADJUSTMENT</b>			
	LIST PRICE			LIST PRICE			
	PIPE SIZE	FS-100		PIPE SIZE	CO-100-S		
	2", 3", 4"	\$798.00		2"-5"*	\$490.00		
ADD FOR OPTIONS:				ADD FOR OPTIONS:			
-3 .....	\$0.00	-33 .....	\$328.00	-VP .....	\$19.00	-Z .....	\$0.00
-4 .....	0.00	-LG .....	Deduct 208.00	-Y .....	0.00	* 5" available in no-hub only	
-31 .....	205.00	-TGI .....	POA				
	<b>12x12x6 ACID-RESISTING INTERIOR FLOOR SINK AND FULL GRATE WITH ALUMINUM INTERNAL DOME STRAINER AND NO-HUB OUTLET</b>			<b>CAST IRON CLEANOUT, ADJUSTABLE NIKALOY RIM AND COVER AND INTEGRAL GAS-TIGHT THREADED PLUG</b>			
	LIST PRICE			LIST PRICE			
	PIPE SIZE	FS-120		TYPE NO.	PIPE SIZE		
	2", 3", 4"	\$844.00		CO-312-Y	2"	\$235.00	
ADD FOR OPTIONS:				ADD FOR OPTIONS:			
-3 .....	\$0.00	-33 .....	\$359.00	-SQ	Square Nickel Bronze Rim and Cover .....	\$26.00	
-4 .....	0.00	-LG .....	Deduct 237.00	-VP	Secured Cover, Vandal-Proof Screws.....	19.00	
-31 .....	259.00	-TGI .....	POA				
	<b>12x12x8 ACID-RESISTING INTERIOR FLOOR SINK AND FULL GRATE WITH ALUMINUM INTERNAL DOME STRAINER AND NO-HUB OUTLET</b>			<b>PVC CLEANOUT WITH ROUND (NIKALOY or CAST IRON) TOP WITH BRONZE PLUG AND SOLVENT WELD BOTTOM OUTLET FOR FITTING OVER 3" AND INSIDE 4" SCH 40 DWV</b>			
	LIST PRICE			LIST PRICE			
	PIPE SIZE	FS-140		PIPE SIZE	CO-430		
	2", 3", 4"	\$901.00		3" x 4" - Nikaloy	\$400.00		
ADD FOR OPTIONS:				ADD FOR OPTIONS:			
-3 .....	\$0.00	-33 .....	\$359.00	-2*	Deduct \$26.00	-VP .....	\$19.00
-4 .....	0.00	-LG .....	Deduct 237.00	-14 .....	41.00	*For Nikaloy Top only	
-31 .....	259.00	-TGI .....	POA				
	<b>12x12x10 ACID-RESISTING INTERIOR FLOOR SINK AND FULL GRATE WITH ALUMINUM INTERNAL DOME STRAINER AND NO-HUB OUTLET</b>			<b>CAST IRON CLEANOUT WITH SECURED ROUND CAST IRON RIM AND COVER WITH INTEGRAL BRASS PLUG AND 4" NO-HUB OUTLET</b>			
	LIST PRICE			LIST PRICE			
	PIPE SIZE	FS-160		PIPE SIZE	TOP		
	2", 3", 4"	\$1,200.00		4"	-CI Rim and Cover (Std)	\$473.00	
ADD FOR OPTIONS:				ADD FOR OPTIONS:			
-3 .....	\$0.00	-33 .....	\$359.00	4"	-NB Nikaloy Rim and Cover	512.00	
-4 .....	0.00	-LG .....	Deduct 237.00	4"	-NB-SQ Square Nikaloy Rim and Cover	512.00	
-31 .....	259.00	-TGI .....	POA				
<b>Lite Line Floor Sink OPTION DESCRIPTIONS</b>			<b>Lite Line Cleanout OPTION DESCRIPTIONS</b>				
-HG	1/2 Grate (PVC)		-2	Satin Finish Bronze Top			
-3Q	3/4 Grate (PVC)		-14	Carpet Cleanout Marker			
-LG	Less Grate		-SQ	Square Nickel Bronze Rim and Cover			
-TGI	Trap Guard Insert		-VP	Secured Cover, Vandal-Proof Screws			
-3	1/2 Grate (Acid-Resisting)		<b>Outlets</b>				
-4	3/4 Grate (Acid-Resisting)		-Y	Hub Outlet w/Gasket 2" -4"			
-31	Aluminum Sediment Bucket		-Z	No-Hub Outle			
-33	Acid-Resisting Finish Sediment Bucket						

**LITE LINE GREASE INTERCEPTORS**

**JG-0100S**



**MANUAL CLEANING ON-FLOOR TYPE**

TYPE NO.	PIPE SIZE	FLOW RATE GPM	GREASE CAPACITY LBS.	LIST PRICE	FOR OPTION, ADD TO LIST PRICE
					-EXT 6"
JG-0102S	2	7	14	\$2,105.00	\$1,500.00
JG-0103S	2	10	20	2,402.00	1,901.00
JG-0104S	2	15	30	2,849.00	2,002.00
JG-0105S	3	20	40	3,203.00	2,168.00
JG-0106S	3	25	50	4,336.00	2,334.00
JG-0107S	3	35	70	5,200.00	2,735.00
JG-0108S	3	50	100	5,949.00	4,336.00
JG-0109S	3	75	150	12,412.00	7,335.00
JG-0110S	4	100	200	15,234.00	8,335.00

**ADD FOR OPTIONS:**

-EXT ..... ABOVE

**LITE LINE SHOCK ABSORBERS**

**SA**



**COPPER SHELL SHOCK ABSORBERS**

LIST PRICE		
SIZE	PIPE CONNECTION	
SA-A	1/2	\$150.00
SA-B	3/4	172.00
SA-C	1	367.00
SA-D	1	436.00
SA-E	1	980.00
SA-F	1	1,471.00



**Quality Engineered  
Plumbing Drainage Products**



**[www.josam.com](http://www.josam.com)**

Michigan City, IN | Philadelphia, PA | 800.365.6726